



Tractors

AXION

870 850 830 810 800

CLAAS



AXION 870-800. Speaks for itself.

AXION 870-800



Impressive in every way.

The AXION 800 in the 200 to 300 hp class offers an outstanding level of driving comfort and ease of operation that makes long working days seem short.

More of everything.

- More help: the self-learning operator assistance system CEMOS makes your job so much easier
- More flexibility: with CEBIS you can view two cameras and control ISOBUS implements
- More pressure: the 205 l/min hydraulic circuit
- More efficiency: the engine speed limiter reduces fuel consumption
- More accuracy: a press of the button is all it takes to switch on the rear PTO and then activate the engine speed memory
- More comfort: a leather steering wheel, hands-free system and rear-opening roof hatch make for a more enjoyable working environment



CLAAS tractors:
from the idea to the
machine.

tractors-making-of.claas.com

AXION 870-800.

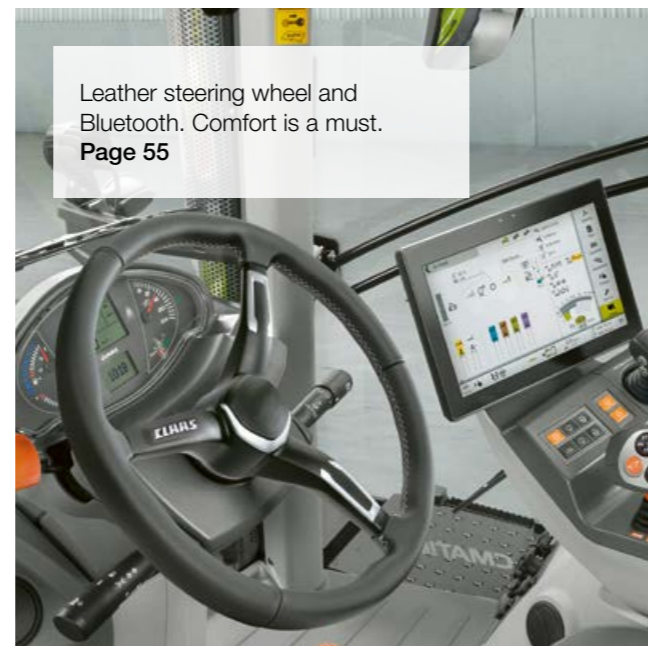
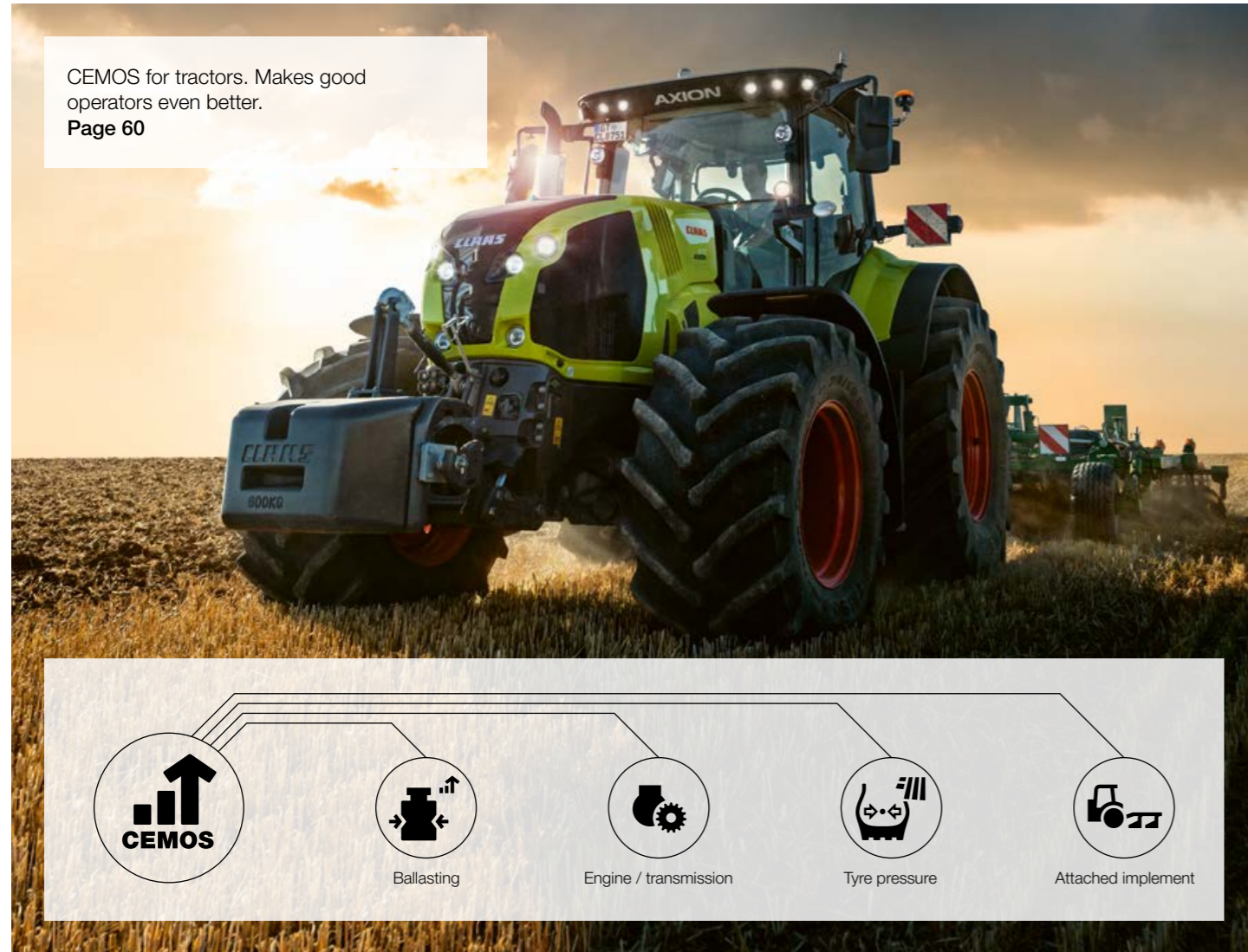

CEMOS – your on-board CLAAS advisor	6
CLAAS POWER SYSTEMS	8
Engine	10
CMATIC	12
HEXASHIFT	18
Construction	24
Safety and manoeuvrability	28
PTO	30
Hydraulics	32
Rear linkage	34
Front linkage	36
Cab and comfort	38
Versions	40
CEBIS	42
CIS+	48
CIS	50
CIS displays	52
Comfort	54
Operator assistance systems and data management	58
CEMOS	60
CSM headland management	62
ISOBUS	64
Steering systems	66
Job management, TELEMATICS	68
Maintenance	70
CLAAS Service & Parts	72
Features	74
Specifications	75



More innovation: more details here.

axion800.claas.com

CEMOS – Makes good operators even better.

The name CEMOS refers to all CLAAS systems which optimise machine performance. For several years CEMOS has been the leading operator assistance system for CLAAS combine harvesters and now it is available for tractors too.

What is CEMOS?

Think of CEMOS as your on-board CLAAS advisor, there to assist you with your daily work. The system suggests setting values and helps the driver continually adjust the machine to the field conditions. CEMOS takes the hassle out of settings and quickly helps the driver optimise machine performance.

The advantages of CEMOS.

- Increases work rate by 11%
- Reduces fuel consumption by 12%
- Reduces tyre wear
- Reduces operating costs by increasing work rates
- Utilises the full potential of the machine
- Reduces implement wear (plough assistant)
- Improves the carbon footprint of your farm

CEMOS makes good operators even better in three simple steps. See page 60 to find out more.



Get the job done quickly and efficiently.
ceмос.claas.com



Our drive system: the perfect interplay between optimal components.

Your CLAAS machine is much more than the sum of its individual parts. Top performance is only possible when all the parts are ideally matched and work together optimally.

In CLAAS POWER SYSTEMS (CPS), we have brought together top-quality components to create an intelligent drive system that sets new standards. Full engine output only when you need it. Drives that are suited to the way your machines are used. Fuel-saving technology which quickly pays off.

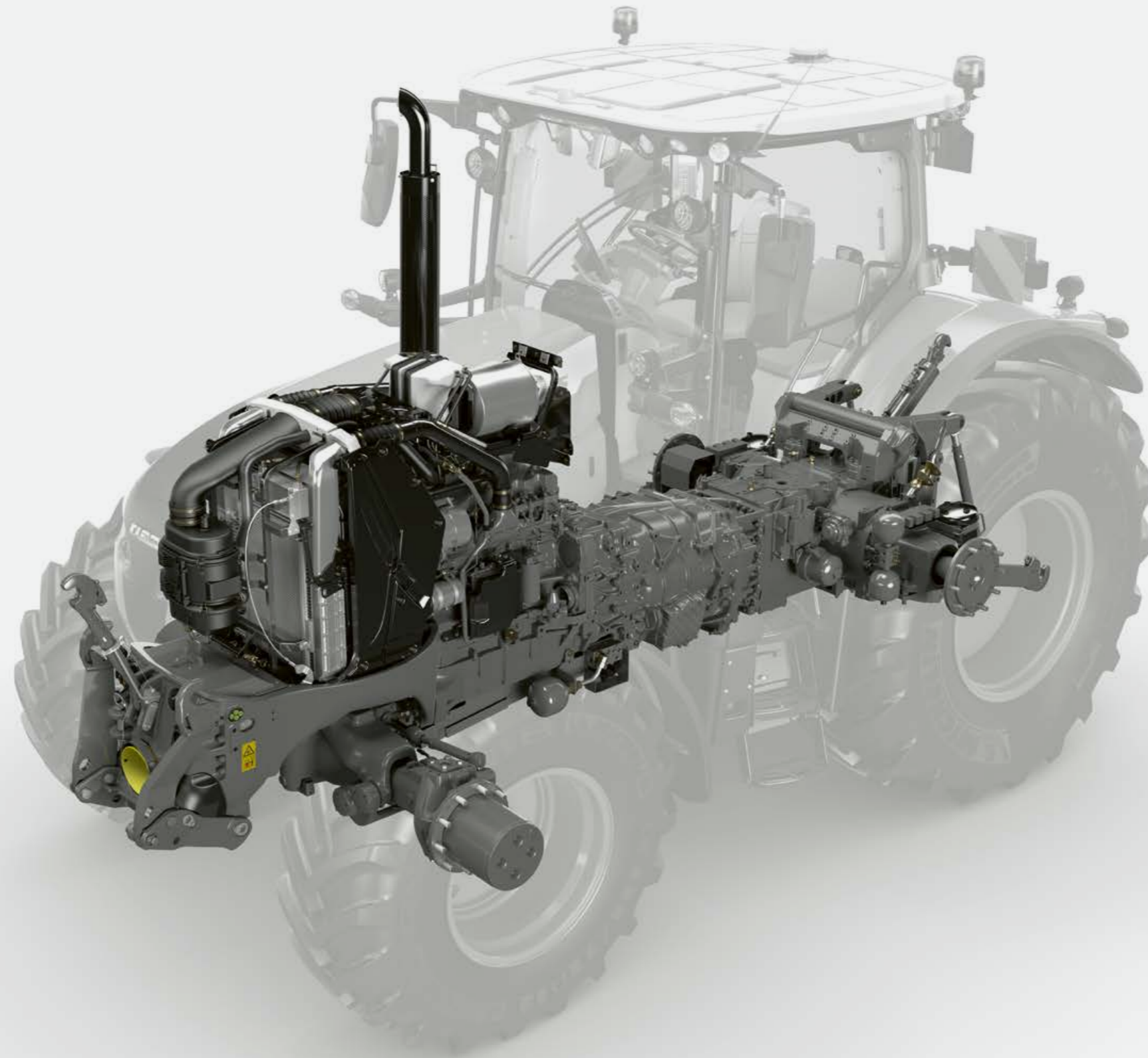

Strong at heart.

A 6-cylinder, 6.7 litre FPT (Fiat Powertrain Technologies) NEF 6 engine gets to work under a one-piece bonnet. The engine meets the requirements of the Stage V emissions standard by incorporating exhaust gas aftertreatment with urea. It uses the latest common rail 4-valve technology, charge-air cooling and a variable geometry turbo (VGT).

Constant output.

The CLAAS-specific engine performance curve provides full torque in a wide engine speed range, guaranteeing constant output and power delivery when they are needed. This makes it easy to save fuel while working at a low engine speed and maximum torque with the ECO PTO, or to work at rated speed with a full reserve. Two engine idling speeds (650 and 800 rpm) with automatic adjustment reduce stationary fuel consumption.

Variable turbo.

The VGT turbo delivers optimum charge-air pressure at any engine speed. It adjusts to load and engine speed, making 70% of maximum torque available even when idling. Optimised combustion therefore means low fuel consumption and maximum performance.

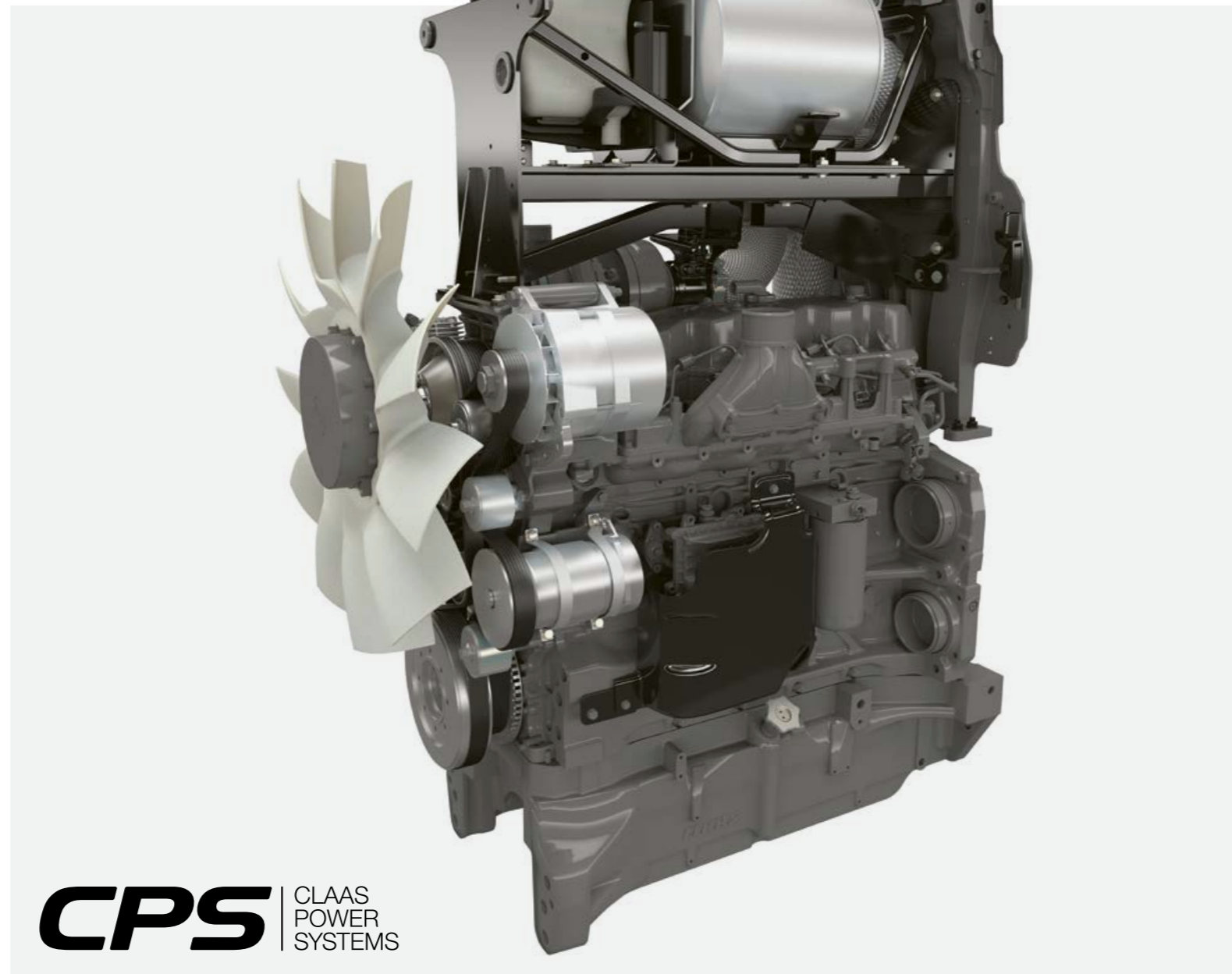

CPS | CLAAS
POWER
SYSTEMS

AXION 870 CMATIC.

The AXION 870 CMATIC delivers up to 295 hp thanks to the intelligent CLAAS POWER MANAGEMENT (CPM) electronic control system. Additional boost power is available for PTO work from 7 km/h, for transport operations and also for the fan drive, significantly increasing the performance and versatility of the AXION 870 CMATIC.

AXION ¹	Torque (Nm)	Maximum output (hp) ECE R 120
870	1276 ²	295 ²
850	1132	264
830	1016	235
810	941	215
800	896	205

¹ Some models are not available in all countries. Please refer to your CLAAS dealer's price list.

² Torque and maximum output with CPM (CLAAS POWER MANAGEMENT).



Stage V thanks to DOC and SCRoF.

When designing the AXION 800 series, we considered all the components required for exhaust gas aftertreatment from the outset. Full visibility and accessibility are therefore guaranteed. The diesel oxidation catalytic converter (DOC) is positioned under the bonnet immediately behind the turbocharger because it needs high exhaust temperatures to produce an optimum reaction. The Selective Catalytic Reduction on Filter (SCRoF) is an integral part of the exhaust system and is located on the right-hand side of the tractor.

Visctronic – efficient fan control.

With Visctronic electronic fan control the fan speed can be precisely aligned with engine temperature and load, ensuring that the engine always runs at the optimum temperature. The reduced fan speed lowers the noise level and saves valuable fuel with no unnecessary impact on output, which can then be converted into tractive power.

CLAAS CMATIC. Continuously variable.

- Mechanical power flow from the engine
- Hydraulic power flow
- Combined power flow
(mechanical + hydraulic to transmission output)

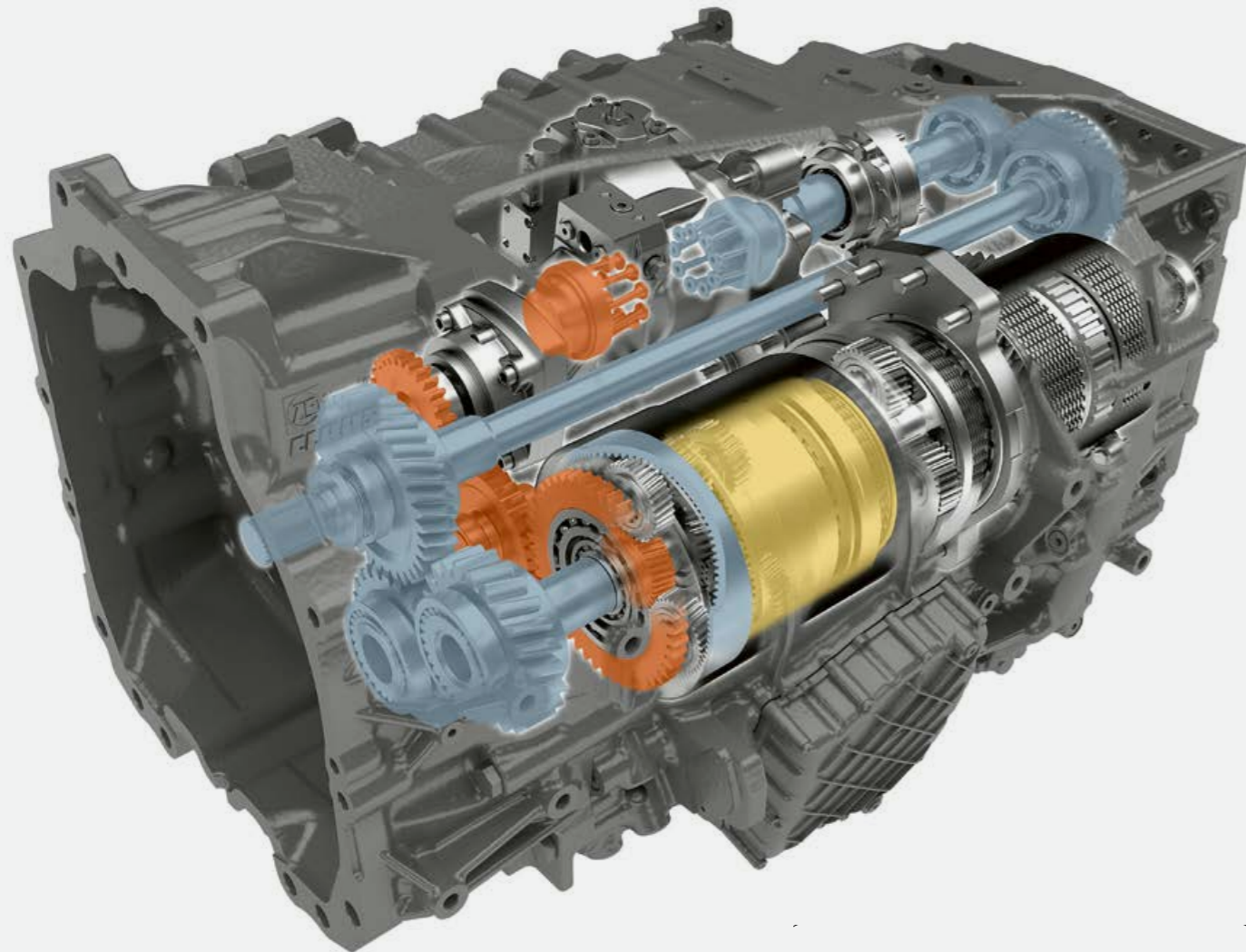

CPS | CLAAS
POWER
SYSTEMS



Efficient and user-friendly.

CMATIC is the name of the continuously variable transmission technology used in CLAAS tractors. In the AXION 800 series a ZF Terramatic transmission provides efficient conversion of engine power. In this split-power, continuously variable transmission, the four mechanical ranges are automatically selected by multidisc clutches. There is no need to shift between ranges manually.

The high mechanical component in the power transmission provides outstanding efficiency and low fuel consumption in every speed range.

Superior transmission control.

Powerful acceleration, smooth deceleration and a fast response to changes in load: CMATIC powertrain management shows its maturity in all conditions and for every task. Stay relaxed and focused throughout the working day so you can concentrate on more important things – CMATIC does the rest for you.

Exploiting real potential.

The available power of the transmission can be used effectively at speeds from 0.05 to 50 km/h. The high level of mechanical power transmission also delivers outstanding driving force in reverse. What's more, every gear ratio can be used at every engine speed, giving AXION 870-800 tractors enormous potential for use all year round.

With engine speeds of 1,600 rpm at a top speed of 50 km/h and 1,300 rpm at 40 km/h, AXION 870-810 tractors also demonstrate their capabilities in transport operations. If the accelerator is not depressed, the transmission is in powered zero mode and maintains its position without creeping or rolling. This means that the tractor can start up safely and easily at steep field entrances or road junctions, even with a full load.



Engine droop setting for "Eco" and "Power", and the engine speed memory

Engine droop at the push of a button.

The engine droop value can be used for quick and easy regulation of the engine speed under full load. The CEBIS or CIS terminal clearly displays the engine speed at which the transmission reduces the speed.

When a constant engine speed is activated, i.e. during PTO work, the driver can specify a different droop setting, typically one that matches the engine speed to the required PTO shaft speed.

Two engine droop values can be saved in accelerator pedal and drive lever mode. They can be retrieved by the quick-access facility using the F buttons. With these "Eco" and "Power" values, the droop can be rapidly adjusted to the task in hand, e.g. when moving from road to field. The engine droop for the engine speed memory is set separately.



Simple, straightforward operation.

The CMATIC transmission has three operating modes: accelerator pedal, drive lever and manual mode.

In the first two modes, forward speed can be controlled by the accelerator pedal or drive lever. The engine speed and transmission ratio are adjusted automatically – for optimum efficiency and optimised fuel consumption. In manual mode, the driver chooses the engine speed and transmission ratio. Automatic engine and transmission control is disabled.

Accelerator pedal or drive lever.

You can switch between accelerator pedal and drive lever mode while the tractor is moving by pressing a button on the armrest. The active mode is displayed in CEBIS or CIS.



Driving mode display in CEBIS.

CMATIC. No need to stop.



Tailor-made speed ranges.

With the CMATIC transmission, three speed ranges can be pre-selected in both directions of travel. The active range is displayed in CEBIS or CIS and can be changed while the tractor is in motion using two buttons. The lower the maximum preset value for the range, the more accurately the forward speed can be controlled.

A cruise control speed can be saved for all the ranges while the tractor is moving by pressing the button on the drive lever. The cruise control speeds can also be pre-set on the CEBIS or CIS terminal.

CMATIC allows drivers to create their own profiles according to the job in hand. Intelligent CMATIC transmission technology enables you to use the full power of your AXION economically and productively – with maximum operator comfort.

Stopping power.

The CMATIC transmission offers different ways of adapting braking to the job in hand.

Increase the engine braking effect:

When the accelerator pedal is released and the multifunction control lever is pulled back, the transmission ratio is reduced, causing the engine speed to increase. The optional engine retarder also comes into play. It engages automatically when it is needed and increases the engine braking effect by up to 2.5 times. This reduces brake wear.

Anti-jackknife brake:

When the trailer is braked with the service brake, you can accelerate at the same time using the accelerator pedal or by pressing the multifunction control lever. This maintains the distance between the tractor and trailer on steep hills and increases safety. These functions can be used whether the tractor is stationary or moving.

CIS+ operation

- 1 Change range
- 2 Activate cruise control



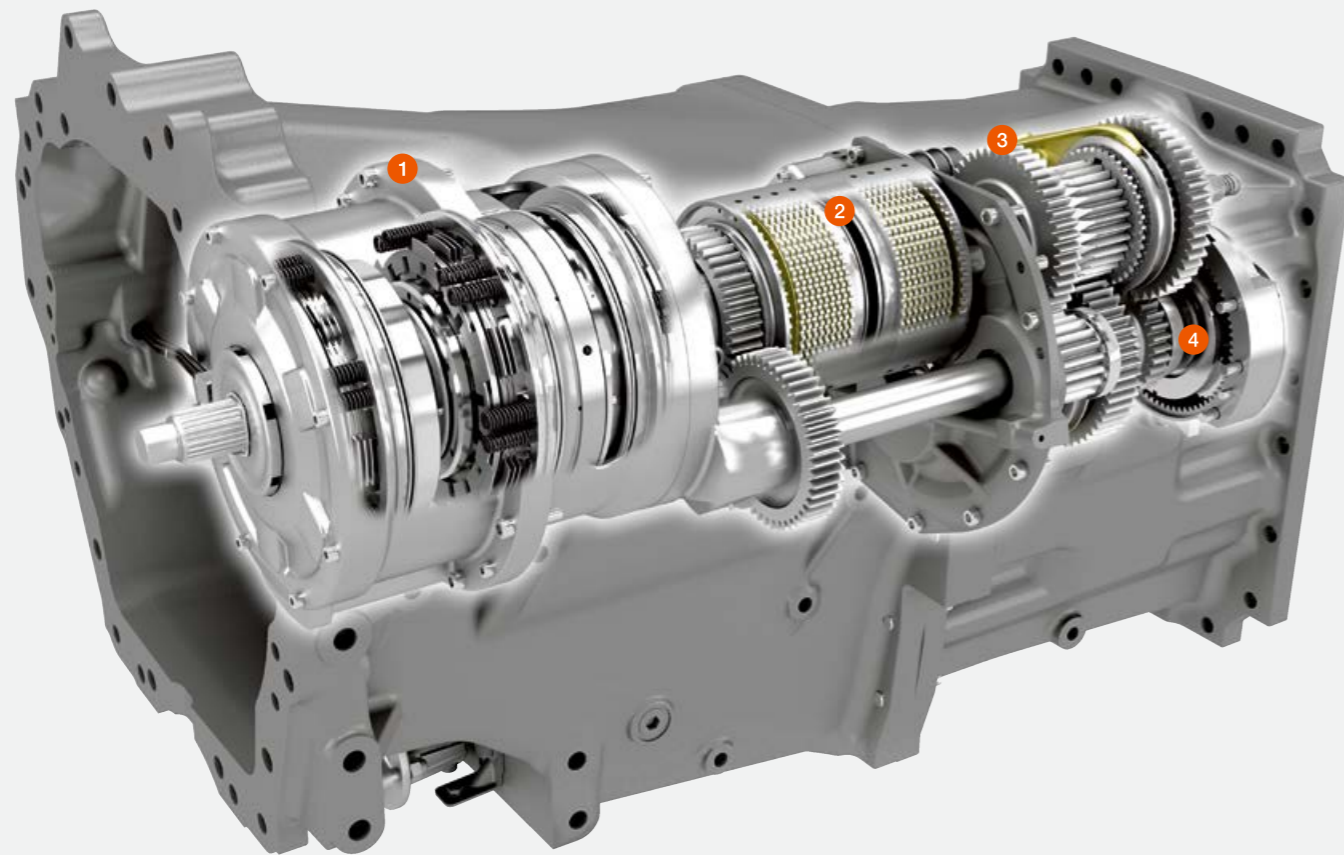

- 1 HEXASHIFT 6-speed powershift module
- 2 REVERSHIFT electronic clutchless reverser
- 3 Electrohydraulically actuated 4-speed range shift
- 4 Optional creep gears



The HEXASHIFT powershift transmission from CLAAS.

With HEXASHIFT you can shift effortlessly through all six powershift speeds and the four automatic ranges using your fingertips, or you can shift automatically using the HEXACTIV auto-shift function.

HEXASHIFT is available in two different versions:

- ECO 40 km/h at 1,950 rpm
- ECO 50 km/h at 1,950 rpm

Overlapping powershift speeds allow the full output potential of the engine to be utilised. This overlap also provides smooth range shifting on the road.

HEXASHIFT: 24 gears for optimum gear spacing

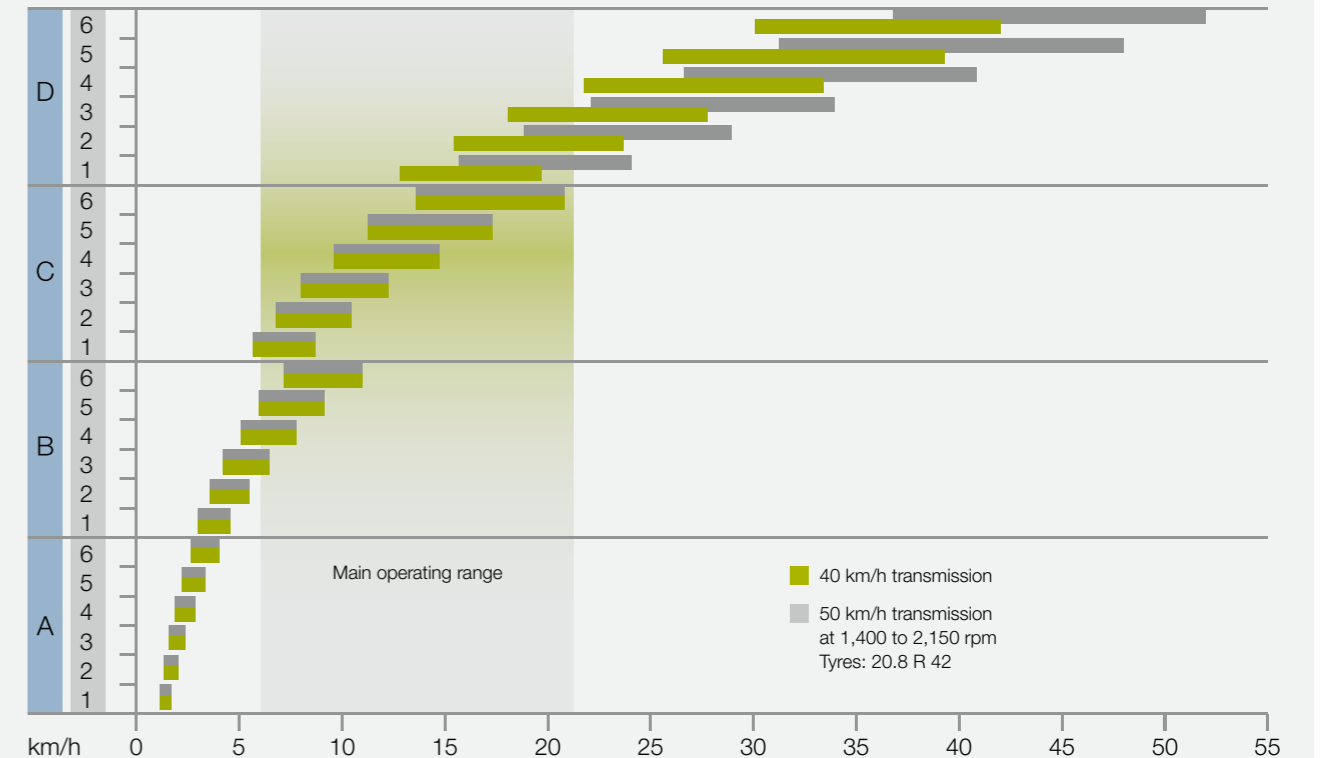

Clear benefits.

- No need to use the clutch when changing range
- Good gear spacing in all ranges
- Twelve gears in the main operating range
- Fully automatic shifting with HEXACTIV
- HEXACTIV auto-shift function with cruise control
- Disable cruise control and engine speed memory using the throttle pedal
- Excellent efficiency in the field and on the road for low fuel consumption
- Creep gear options down to 450 m/h
- Convenient adjustment options with CIS or CEBIS
- High operating comfort with the DRIVESTICK or CMOTION
- CLAAS powertrain management for smooth changes in range and powershift operations
- REVERSHIFT clutchless reverser with electronic parking brake
- SMART STOP: stop with the brake pedal without using the clutch
- REVERSHIFT reversing function on the ELECTROPILOT four-way control lever

HEXASHIFT.

Always in the right gear.

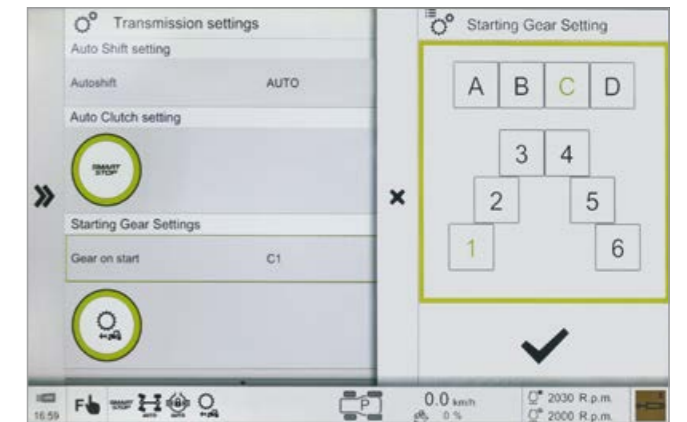
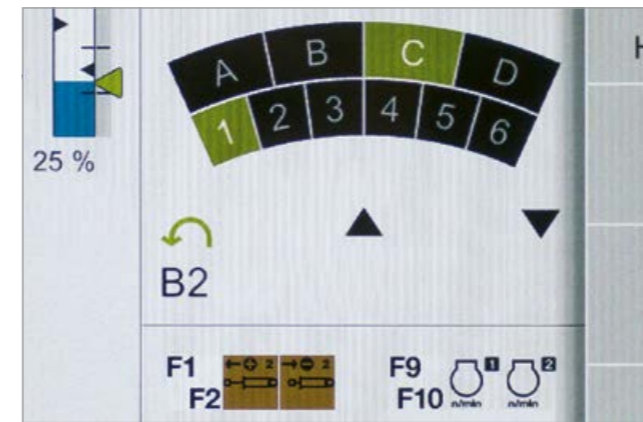

Intelligent transmission settings.

When using the clutchless reverser, you can even change gear automatically when you want the forward speed to be different from the reverse speed. At the headland, you can also engage a pre-selected gear simply by pressing a button. This means that you are always moving at the same speed on the headland. The aggressiveness of the REVERSHIFT clutchless reverser is also adjustable in nine steps (-4 to +4), providing optimum ride comfort in all situations.

HEXACTIV start-up and approach gears.

The start-up gear engaged when starting the engine is freely selectable between A1 and D1. The specified start-up gear is engaged every time you start the engine. A separate approach gear can also be selected when operating with the HEXACTIV auto-shift function activated. This gear is automatically engaged as soon as the tractor comes to a standstill.

Automatic transmission control.

There's no need to move through every gear (as in a conventional powershift transmission) when shifting between ranges – the HEXASHIFT transmission automatically selects the most appropriate gear depending on forward speed and load, regardless of whether you are driving manually or automatically. If you press the clutch in range D, the transmission automatically adjusts the powershift speed when the clutch is re-engaged. This can be very useful, e.g. when approaching a junction.



Intelligent gear selection on the A-pillar display in the CIS version.

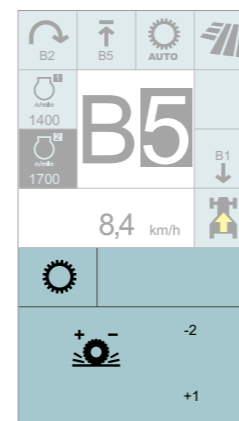

REVERSHIFT progressivity in CIS.

SMART STOP and cruise control.

With the SMART STOP function, AXION 800 tractors can be brought to a standstill by pressing the brake, without needing to use the clutch pedal. This lightens the driver's workload considerably, especially during tasks which involve a lot of stopping and starting such as making round bales and front loader work. SMART STOP is easily activated in CEBIS or CIS. The HEXACTIV auto-shift function can be equipped with a cruise control function. Instead of a fixed engine speed, a target forward speed is specified by pressing a button and the tractor maintains this speed by adjusting the engine speed and gear ratio.

NEW: engine speed limiter.

The engine speed limiter is a great help when it comes to saving fuel. Simply set the maximum engine speed in advance and then you can focus fully on your work. The engine maintains the set speed regardless of how hard you depress the accelerator. This allows you to cut fuel consumption significantly.

HEXASHIFT. HEXACTIV changes gear for you.



HEXACTIV auto-shift function.

Because you've got more important things to do, you can leave HEXACTIV to change gear automatically. You can configure the HEXACTIV auto-shift function with a wide range of well-designed functions according to your preferences and the job in hand.

- Fully automatic: HEXACTIV shifts for variations in engine speed depending on engine load, vehicle speed and the driver's preference/accelerator position
- PTO mode: HEXACTIV shifts so as to ensure that the engine speed/PTO speed remain as constant as possible
- Manual mode: HEXACTIV shifts according to a fixed engine speed which is programmable by the driver

You can choose between three modes for the auto-shift function in CEBIS or CIS.

Setting the three modes in CEBIS:



Fully automatic mode

PTO mode

Manual mode

Manual shifting	Driving strategies	Mode	Shifting
	<p>Manual shifting in field mode</p>		<ul style="list-style-type: none"> - Range shifting (A-D) by pressing the DRIVESTICK or CMOTION through the stop - Powershift shifting (1-6) by tapping the DRIVESTICK or CMOTION
<p>Manual shifting in transport mode</p>		<ul style="list-style-type: none"> - Shift through all 24 gears (A1-D6) by tapping the DRIVESTICK or CMOTION 	

HEXACTIV auto-shift function	Driving strategies	Mode	Shifting
	<p>Automatic shifting in field mode</p>	 	<ul style="list-style-type: none"> - Range shifting (A-D) by pressing the DRIVESTICK or CMOTION through the stop - Automatic powershift shifting (1-6)
<p>Automatic shifting in transport mode</p>	 	<ul style="list-style-type: none"> - Shift all 24 gears (A1-D6) automatically 	

Setting the three modes in the colour CIS:

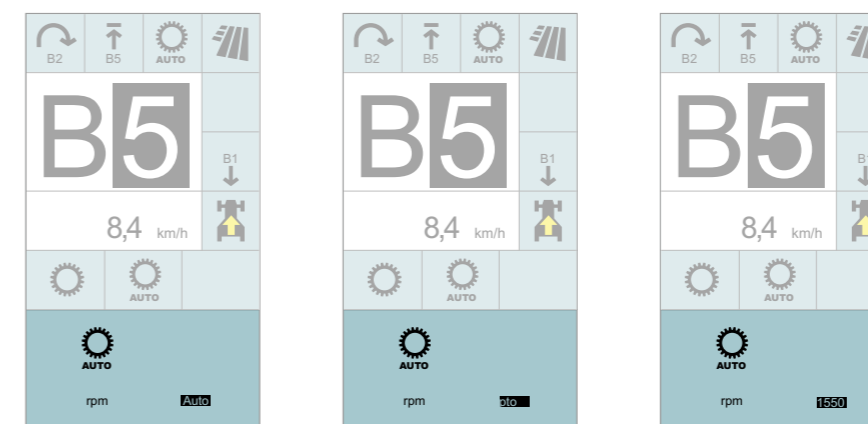

Fully automatic mode

PTO mode

Manual mode

Stable and manoeuvrable.
Immense tractive power.



Slim waist for tight turns.

CLAAS has drawn on experience gained in developing standard tractors up to 400 hp or more to create a perfectly coordinated solution for the AXION 800 series – for endurance work under extremely challenging conditions. The engine is housed in a strong frame section with an integrated engine oil sump which absorbs all the forces associated with the front linkage and front chassis.

The specially shaped front chassis provides plenty of space for the radiators immediately above the front axle. In front and behind it is designed to be very narrow, like a wasp waist. This gives an excellent steering lock angle and small turning circles.

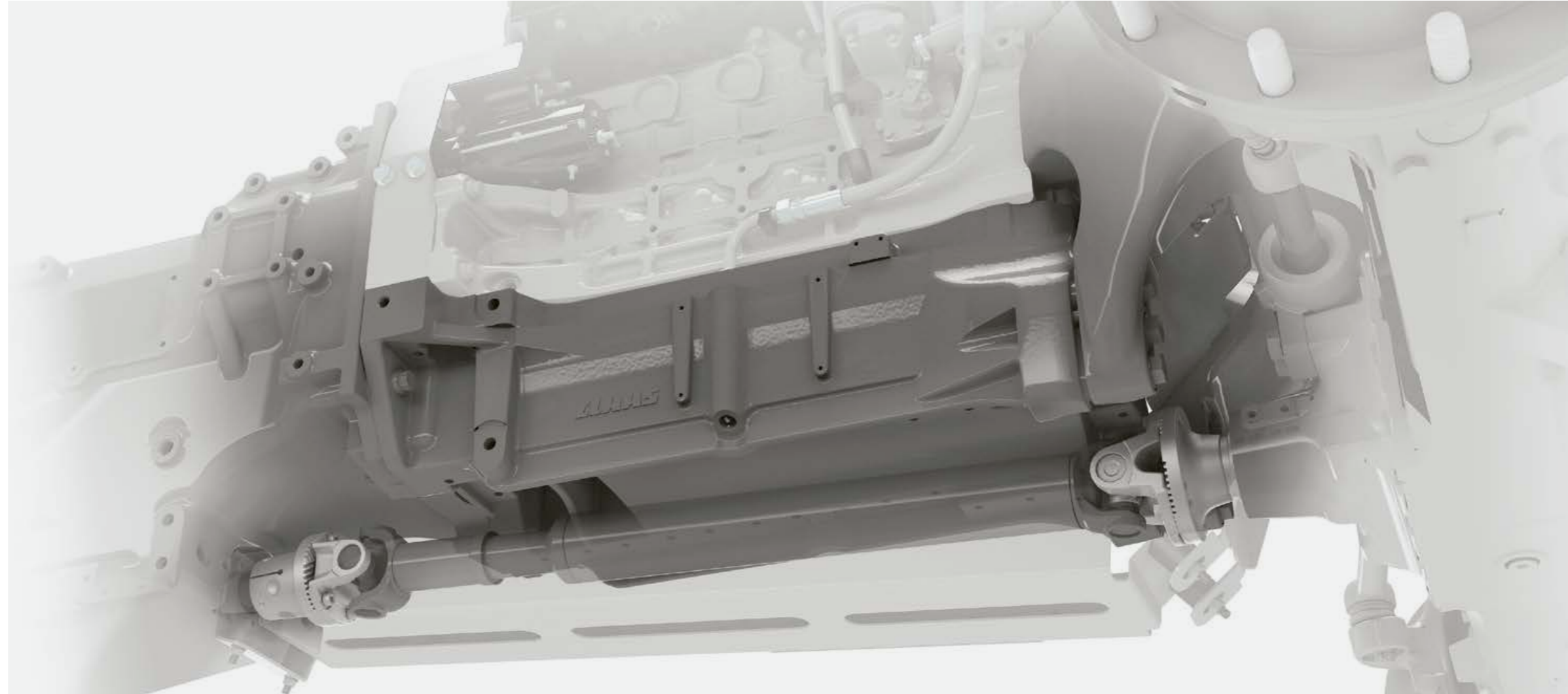

In practice, this means:

- Maximum stability even when using heavy front-mounted implements
- Excellent steering lock angle for maximum manoeuvrability
- Optimum access to the entire engine compartment and all maintenance points

Key benefits:

Long wheelbase:

- High driving comfort
- Directional stability
- Higher tractive power due to better weight distribution
- Good and safe road handling
- Higher lifting power due to better weight distribution



Short overall length:

- Good manoeuvrability
- Short trailer combination on the road
- Good visibility
- Good guidance of front-mounted implements



Good power to weight ratio:

- Optimises fuel consumption
- Low ground pressure during crop care work
- Dynamic road transport
- 50 : 50 weight distribution front / rear



Fully balanced.

With so many front and rear axle ballast options, the AXION is easily adapted to every application. This is the only way to utilise its full performance potential without unnecessary losses. If you need to carry out heavy work at low speeds, you can increase the ballasting on the AXION very easily. Weight that is no longer needed can also be removed quickly.

For flexible ballasting on the fixed weight carrier or front linkage, the combinations available ex factory are as follows:

- 600 kg
- 900 kg
- 1,200 kg (600 + 600)
- 1,500 kg (900 + 600)

Wheel weights for rear axle, in kg

38" rim	42" rim
2 x 259	2 x 220
2 x 337	2 x 409



Power and endurance.

The rear tyres on AXION 800 tractors can be up to 2.05 m in diameter. Tyres up to 1.60 m diameter are used on the front axle. The numerous tyre options make the AXION capable of any type of work. Even with the biggest tyres (900/60 R 38) the tractor has an external width of less than 3.0 m, making it flexible on the road and gentle on the field.

AXION footprint

- AXION 870-810 CMATIC and 850-830 HEXASHIFT:
 - Rear tyres up to 900 mm wide and 2.05 m in diameter
- AXION 810 / 800 HEXASHIFT:
 - Rear tyres up to 710 mm wide and 1.95 m in diameter
- Dual tyres¹ for AXION 870 / 850:
 - Flange-mounted on quick-release axle even for heavy traction work
 - Dual tyres up to 650 mm wide

¹ Dual tyres are not available in all countries. Please refer to your dealer's price list.



CTIC tyre pressure adjustment system.

The right tyre pressure protects the soil and benefits the yield in the long term. But it offers other economical advantages too, such as increased tractive power, reduced fuel consumption and low tyre wear. The spool valves are integrated into the patented rotary transmitters to ensure direct high-precision tyre pressure measurement and control at the wheel. The tyre pressure is continually monitored and automatically adjusted.

In the basic version, the CTIC is supplied by the tractor compressor. The CTIC 2800 version has its own screw compressor with an airflow rate of 2,800 l/min. We recommend the CTIC 2800 if you frequently switch from field to road or want to adjust the tyre pressure to suit the trailed implement.





Trailer brake system.

The AXION can be fitted with a pneumatic and a hydraulic trailer brake system in order to meet country-specific requirements. Both systems can be operated simultaneously and the connections are easily accessible on both sides of the drawbar.

Dynamic steering.

Dynamic steering allows the driver to adjust the ratio between the steering wheel and front axle steering angle to suit their preferences. Using CEBIS or the CIS colour display, the driver can choose between two automatic programs and one manual mode, and also select the intensity of the steering ratio.

The two automatic programs adjust the steering ratio according to the forward speed or current steering lock. This means that the system can be individually adjusted to suit all requirements. In steering angle-dependent mode, the steering ratio is greatly reduced when travelling in a straight line. The more the driver steers, the faster the steering responds. This allows the driver to steer the tractor in a straight line with great precision but still manoeuvre quickly.

In speed-dependent mode, the steering ratio is proportionally reduced as the forward speed increases above 10 km/h.

This is particularly useful during field work. As the tractor slows down at the headland, the driver can turn quickly with ease. As the tractor picks up speed, the steering ratio is reduced again to make it easier to drive straight ahead.

In manual mode, the ratio between steering wheel and steering angle is permanently linked to the four adjustable assistance levels.

Setting dynamic steering in the CIS colour display.

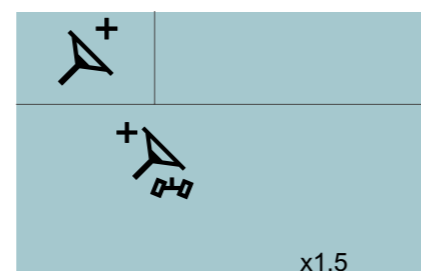

REVERSHIFT with park-lock function.

In addition to the familiar, easy-to-use clutchless reverser, the REVERSHIFT lever also has an integral park-lock function which provides a very easy way of keeping the AXION stationary. For even greater safety, the park-lock function is automatically activated in the following situations:

- When the engine is switched off
- When the engine is switched on
- If the accelerator or CMOTION has not been touched for a few seconds while the vehicle is stationary – regardless of the current REVERSHIFT lever position¹
- As soon as the driver's seat is vacated when the vehicle is stationary¹

¹ Only with CMATIC

Automatic adjustment.

During braking, the front axle suspension automatically adjusts to the change in load. The tractor therefore retains its normal stability and safety even during sharp braking manoeuvres.



Powerful and economical at the push of a button.

The right speed every time.

Three different PTO options are available for all AXION 800 models:

- 540 / 1000 rpm
- 540 / 540 ECO / 1000 rpm
- 540 ECO / 1000 / 1000 ECO rpm

The PTO speed is easily pre-selected at the touch of a button. Another button on the armrest activates the PTO.

Automatic PTO engagement/disengagement is activated at a specified linkage height which is continuously adjustable. To save the height, you just move the rear linkage to the required position and give a long press on the automatic PTO button.

The integral freewheel on the rear PTO makes implement hitching simple.

Standing start.

The 540 / 1000 rpm PTOs reach their full speed precisely in the maximum engine output range. As a result, even heavy PTO-driven implements are no problem for these tractors. In ECO PTO mode the engine runs at a low, fuel-efficient speed. During light work, the lower engine speed can reduce noise levels and save valuable fuel.

Rotational speeds:

- 1000 rpm ECO at 1600 engine rpm
- 540 rpm ECO at 1520 engine rpm



NEW: PTO with the right engine speed.

A press of a button on the rear mudguard is all it takes to switch on the rear PTO and then activate the engine speed memory. Just set the right engine speed for the attached implements in CEBIS in advance. This is recommended for all operations when you routinely use the external PTO switch. It saves time and makes your job easier and safer.



External controls for rear PTO on both mudguards.



The PTO stub can be changed easily.



Powerful hydraulics. Simple connections.

Pressure-free connections and no mess.

All ten hydraulic couplings at the rear of AXION 870-800 tractors have release levers, so they can be connected and disconnected even under pressure.

Coloured markings on the inlet and outlet sides make it easier to attach implements correctly. Oil leakage lines collect the oil from the couplings when attaching and removing connectors.

Hydraulics that get the job done.

- Load-sensing hydraulic system for all AXION 800 models with 110, 150 or 205 l/min output
- With CIS: four mechanical spool valves operated from the right-hand side console and ELECTROPILOT controls for two electronic spool valves on the armrest
- With CIS+: up to six electronic spool valves can be operated from the armrest – up to four of these with the ELECTROPILOT
- With CEBIS: controls for up to seven electronic spool valves on the armrest – four of which can be operated by ELECTROPILOT. Thanks to free assignment and prioritisation of the spool valves, every driver can adapt CEBIS operation according to the task in hand and personal preference. The frequently-used hydraulic functions are positioned side by side for smooth operation.
- With CEBIS and CIS+: spool valve operation can be assigned to the F buttons on the CMOTION, multifunction armrest or ELECTROPILOT to lighten the workload during combined operating processes.



Power Beyond.

Power Beyond connections are provided at the rear for implements which have their own control units.

In addition to the standard pressure, return and signal lines, the tractor also has a free-flow return line. The AXION is therefore prepared for operation of hydraulic motors with a separate return line, even when the Power Beyond connections are in use.

The benefits of this are:

- Hydraulic oil is supplied to the attached implement as required
- Large-diameter lines and non-pressurised return flow reduce power losses



When a front linkage is installed, up to four hydraulic connections and one free-flow return line are available at the front. Ideal for a front-mounted seed hopper or dozer blade.

Equipment	CIS	CIS+	CEBIS
Max. number of mechanical spool valves, rear	4	–	–
Max. number of electronic spool valves, rear	–	4	5
Max. number of electronic spool valves, centre, e.g. for connections to the front or a front linkage; operated from ELECTROPILOT	2	2	2
Spool valve prioritisation	–	–	□
Free spool valve assignment	–	–	□

□ available – not available

Lifts any implement. The rear linkage.



External controls for the rear linkage, PTO and one freely selectable spool valve (CEBIS only).



Several positions are available in the drawbar versions. The extended position improves manoeuvrability.

A hitch to suit every need.

The tow hitch support on the AXION is ISO 500 compliant. This means that hitches on other machines which conform to the same standard can be used. A wide range of factory-fitted hitch options is available:

- Pick-up hitch
- In the drawbar frame:
 - Automatic clevis, 38 mm
 - K80 hitch ball and positive steering (up to 4.0 t drawbar load)
 - CUNA hitch system
- As a drawbar:
 - With Cat. 3
 - With K80 hitch ball and positive steering (4.0 t drawbar load)
- Tow hitch support with Piton-Fix coupling

Direct adjustment.

The main rear linkage functions are directly accessed via push buttons and dials on the right-hand B-pillar:

- Manual lift and lower for machine attachment
- Vibration damping on / off
- Lock rear linkage
- Activate slip control
- Lifting height limiter
- Lowering speed
- Draught and position control
- Adjustment of wheel slip control

The convex rear window and swivelling seat provide an excellent view of the implement and unimpeded operation of the rear linkage controls. The conveniently located controls enable the driver to optimise the rear linkage settings while work is in progress.

The rear linkage.

With a maximum lifting capacity of 10 t, these tractors can carry the heaviest of implements. The configuration of the rear hydraulic system can be tailored to individual requirements:

- Manual or automatic lower link stabilisers
- Wheel slip control via radar speed
- Hydraulic top link
- Practical ball holder at the rear
- Excellent view of linkage and drawbar
- Both mudguards are fitted with external controls for the rear linkage, PTO and one electronic spool valve (CEBIS only)



More versatility.
More applications.



Front linkage.

All AXION 800 models can be factory-fitted with two different front linkages:

- 4.6 t max. lifting capacity
- 5.8 t max. lifting capacity

The modular construction means that retrofitting can be carried out easily.

Front linkage and front PTO.

All models feature a front linkage and front PTO:

- Three positions for the front lower links: folded up, fixed working position and float position in slotted hole
- Double-acting lift rams as standard
- Short distance between front axle and mounting points for improved guidance of front attachments
- 1000 rpm PTO
- External control of the front linkage and one double-acting spool valve in the CEBIS version if fitted



Always connected.

Optional hydraulic and electronic interfaces for many applications are incorporated into the front linkage:

- Up to two double-acting spool valves
- Free-flow return line
- 7-pin socket
- ISOBUS socket



External controls for the front linkage and one spool valve in the CEBIS version.

Precise work.

The optional front linkage position control system for the CEBIS version enables front-mounted implements to work extremely accurately. The working position is adjusted via a rotary knob on the armrest, while the lifting height can be limited and the lifting and lowering speed can be set using CEBIS. The front linkage can be used in single- or double-acting mode.

Greater comfort means higher productivity.

Spacious and quiet, with large windows and full suspension: the cabs on AXION tractors guarantee maximum comfort throughout long working days.

- CEBIS version with touchscreen operation and innovative CMOTION multifunction control lever
- CIS+ version with colour display, multifunction armrest and DRIVESTICK
- CIS version with mechanical spool valves, multifunction armrest and DRIVESTICK



A clear view. The cab.

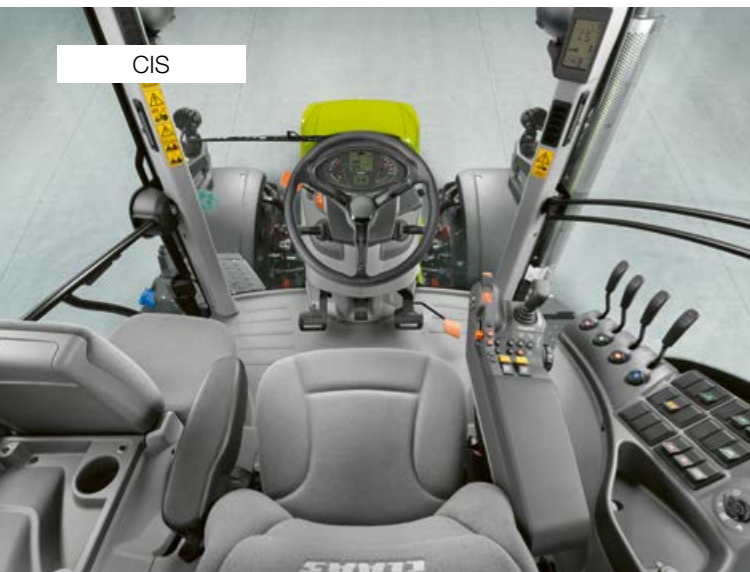

CIS

CIS. Simply good.

In the basic version, the AXION has mechanical spool valves and the CLAAS INFORMATION SYSTEM (CIS). The CIS display features a compact design and outstanding control ergonomics: all settings are easily activated using a rotary/push switch and the ESC button. Two electronic spool valves for connections to the front or the front linkage are also available as an option in the CIS version and are operated via the ELECTROPILOT on the armrest.

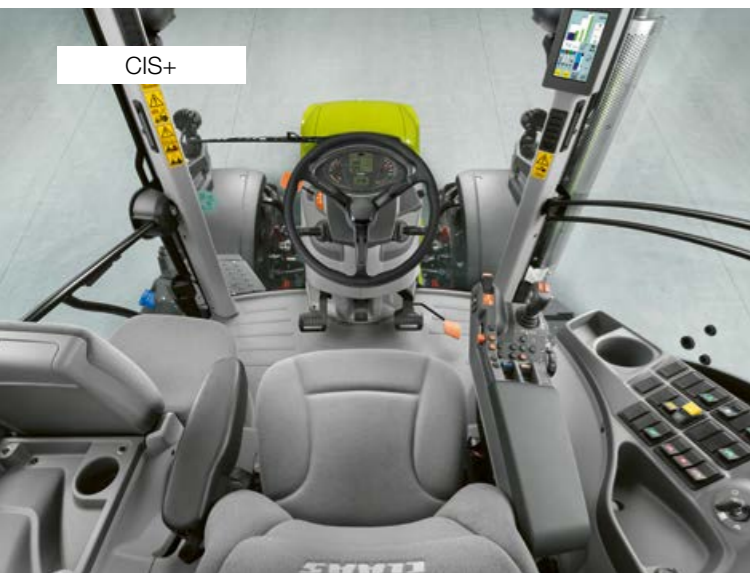

CIS+

CIS+. Simply more.

CIS+ affords impressive ease of use and an intuitive design. Despite its pleasing simplicity, it has all the necessary functionality and the automatic functions needed for effective, effortless operation. CIS+ is also available with a continuously variable CMATIC or HEXASHIFT powershift transmission. The 7" CIS colour display built into the A-pillar combines display and setting options for the transmission, electronic spool valves, F buttons and CSM headland management.

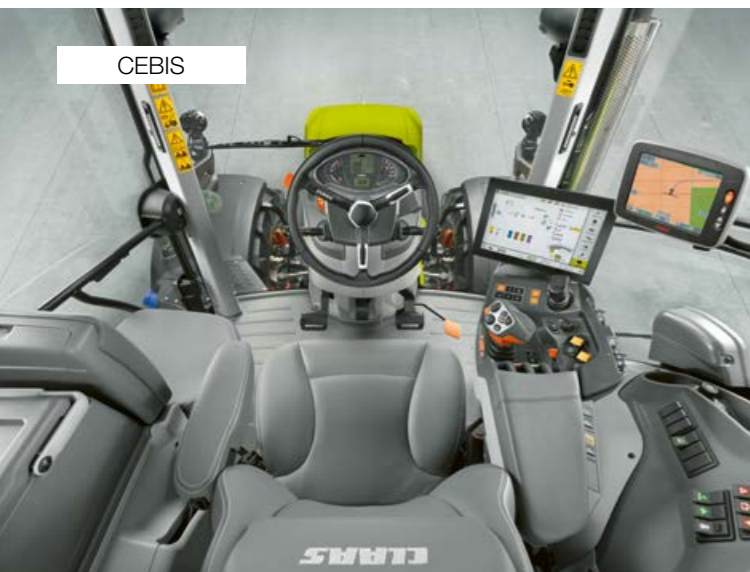

CEBIS

CEBIS. Simply everything.

With the CMATIC or HEXASHIFT transmission, the CEBIS version features electronic spool valves and the superb CEBIS terminal with a 12" touch display. As well as enhanced automatic functions such as CSM headland management, camera image, ISOBUS implement control, CEMOS for tractors and spool valve prioritisation, it also offers many other functions – CEBIS meets your every need. All settings can be entered in seconds thanks to touchscreen operation and logical menu navigation.

4-pillar concept.

The CLAAS 4-pillar cab offers some distinct advantages:

- Clear view of the full working width of attached implements
- Large-volume cab creates an extremely spacious working environment
- Continuous windscreen

The layout and positioning of the controls are inspired by the design of the CLAAS AXION 900 and ARION 600 / 500 series. The controls and menu structure of the CIS, CIS+ and CEBIS versions are the same in all models. The CMOTION multifunction control lever has also become an established feature of CLAAS harvesters. CLAAS places great emphasis on having a standardised control structure so that every driver immediately feels at home in the cab and knows how to operate the controls right from the start.

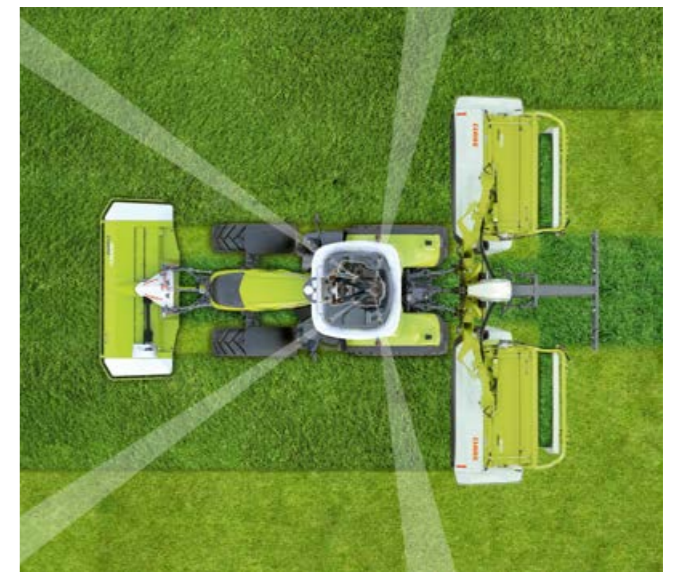

The cleverly positioned rear cab pillars and convex rear window give the driver an excellent view of the implement and hitch area.

AXION equipment	CIS	CIS+	CEBIS
CIS display in the A-pillar, DRIVESTICK and multifunction armrest	●	–	–
CIS colour display in the A-pillar, DRIVESTICK and multifunction armrest	□	●	–
CEBIS touchscreen terminal, CMOTION multifunction control lever and multifunction armrest	–	–	●
CMATIC transmission	–	□	□
HEXASHIFT transmission	●	□	□
PTO shaft management	●	●	●
Max. number of mechanical spool valves	4	–	–
Max. number of electronic spool valves	2	6	7
Max. number of electronic spool valves operated by ELECTROPILOT	2	4	4
CSM headland management	–	□	–
CSM headland management with edit function	–	–	●
On-board computer functions	□	●	●
Implement management	–	–	●
Job management	–	–	●
Camera image	–	–	□
ISOBUS implement control	–	–	□
CEMOS for tractors	–	–	□
TELEMATICS	□	□	□
ICT (Implement Controls Tractor)	–	□	□

● standard □ optional □ available – not available

CEBIS version. Simply everything.

An armrest that sets new standards.

All the main controls are integrated into the right-hand armrest:

- 1 CMOTION multifunction control lever
- 2 Control panel for drive mode, range changing and two engine speed memories with fine adjustment
- 3 CEBIS terminal with 12" touchscreen
- 4 ELECTROPILOT with two double-acting spool valves and two F buttons
- 5 CEBIS control panel
- 6 Working depth adjustment for front and rear linkage
- 7 Activate front and rear PTO
- 8 Hand throttle
- 9 Transmission in neutral, activate front linkage
- 10 Electronic spool valves
- 11 Four-wheel drive, differential lock, automatic PTO engagement/disengagement, front axle suspension
- 12 Main switch: battery, electronic spool valves, CSM, steering system

The height and position of the armrest can easily be adjusted to the driver's requirements.

Functions that are used less frequently, such as PTO speed preselection and the main switches, are located to the right of the driver's seat. When the driver's seat is rotated, the electronic linkage control system can be operated comfortably with an excellent view of the attached implement. This allows settings to be finely adjusted while work is in progress. Two additional buttons enable the rear linkage to be raised and lowered manually for easier implement attachment.



Clear, logical layout.

In all versions, many functions can be controlled directly using the rotary switches and buttons on the B-pillar:

- A PTO speed selection
- B Rear linkage settings
- C Rear linkage status display
- D Controls for electronic rear linkage control system

CMOTION multifunction control lever. Everything in hand.



CMOTION multifunction control lever.

The CMOTION is a CLAAS concept which makes using the main functions of the AXION easier and more efficient. Functions are controlled using your thumb and forefingers, allowing your hand to stay in one place for the majority of time and preventing fatigue.



Operating the HEXASHIFT or CMATIC.

All HEXASHIFT shifting operations are carried out using the CMOTION. A slight push activates the powershift speeds.

By pushing the CMOTION further forwards or backwards, it is possible to select ranges directly and skip powershift speeds. With the CMATIC, the forward speed can be adjusted precisely and continuously using the CMOTION.



Progressive operation with CMATIC continuously variable transmission technology.



Shifting operation, powershift speeds + / - Shifting operation, range + / -

At the push of a button.

The free assignment option for the ten function buttons on the CMOTION means that there is no longer any need to reposition your hands while you work. All implement-specific ISOBUS functions are easily controlled using the CMOTION:

- ISOBUS functions
- Event counter on/off
- Spool valves

Rear linkage functions on the CMOTION:

- Lower to preset working position
- Raise to preset lift height position
- Manual activation: lift and lower at two speeds (slow/fast)
- Quick implement entry

- 1 Start up/change direction
- 2 Rear linkage
- 3 GPS PILOT activation
- 4 CSM headland management
- 5 Function buttons F7 / F8 / F9 / F10
- 6 Activate cruise control
- 7 Function buttons F1 / F2
- 8 Function buttons F5 / F6

CEBIS terminal. Everything under control.



Clear layout and fast operation.

The 12" CEBIS screen uses self-explanatory symbols and colour coding to give a clear picture of the settings and operating statuses. Thanks to the CEBIS menu structure and touchscreen, all settings can be entered in just a few steps. A particularly attractive feature is the DIRECT ACCESS function with the machine silhouette. Just tap the relevant area to get straight to the right dialogue window.

An eye-catching 12" screen.

- 1 Machine silhouette for DIRECT ACCESS and status display
- 2 Spool valve status
- 3 Vehicle information
- 4 Top sub-field: performance monitor
- 5 Middle sub-field: function button assignment
- 6 Bottom sub-field: transmission information
- 7 Menu
- 8 DIRECT ACCESS via CEBIS touch button or button on the armrest
- 9 Dialogue-based system for optimum settings

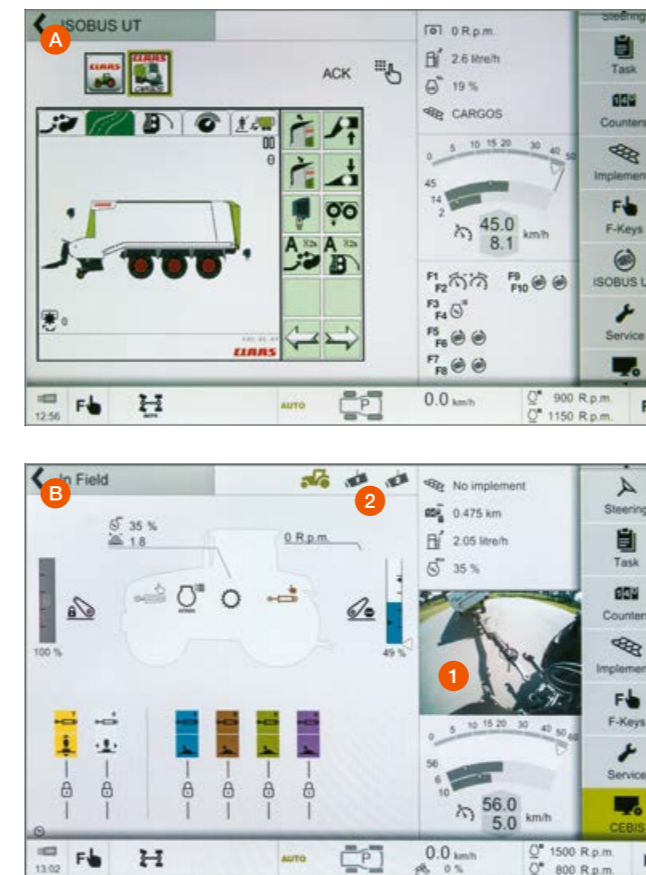

CEBIS – simply better:

- Fast and intuitive navigation using the CEBIS touchscreen
- Rapid access to the sub-menus with the DIRECT ACCESS touch button on CEBIS or button on the armrest
- Tap the machine silhouette, main field or sub-field
- Navigate using the rotary/push switch and ESC button on the armrest – ideal when driving on rough terrain
- Two different screen layouts available (road travel and field work)
- ISOBUS function
- Specify the user type: limit the scope of CEBIS settings to suit driver experience
- Freely assign the three sub-fields, e.g. for transmission, front and rear linkage, function buttons, headland sequences, camera or performance monitor

As well as screen-based operation with CEBIS, there is a set of buttons in the armrest. Full CEBIS operation is available using the rotary/push switch and ESC button if uneven ground reduces the accuracy of fingertip operation. The DIRECT ACCESS button takes you straight to the settings for the last used tractor function.

NEW: integrated ISOBUS implement control (A).

- In CEBIS intuitively switch between ISOBUS implements, road travel and field work screen layouts
- Clear view of ISOBUS implements in main field
- Simply connect ISOBUS cable at the front or rear and off you go
- Assign up to ten ISOBUS functions to CMOTION function buttons for direct operation

New: camera image display function (B).

- 1 Display up to two camera images in the sub-field
- 2 Toggle between machine silhouette, Camera 1 and Camera 2 in the main field



- 1 Menu navigation
- 2 Select
- 3 ESC button
- 4 DIRECT ACCESS button



Everything to hand.

The height and position of the armrest can easily be adjusted to the driver's requirements.



- 1 DRIVESTICK to operate the CMATIC or HEXASHIFT transmission
- 2 Controls for rear linkage and two F buttons, e.g. to activate CSM headland management
- 3 Hand throttle, two engine speed memories, GPS PILOT, four-wheel drive and differential lock
- 4 ELECTROPILOT four-way control lever with two F buttons and buttons to change direction
- 5 Control panel for transmission and hydraulic function activation
- 6 Electronic spool valves
- 7 Set working depth of rear linkage
- 8 Activate front and rear PTO plus automatic engagement/disengagement of rear PTO
- 9 Activate front axle suspension



The perfectly ergonomic armrest.

The multifunction armrest has been designed for optimum ergonomics and is the key to relaxed and effective working. It's the result of extensive analyses of the operating processes in the cab: frequently required functions are located on the multifunction armrest, while those required less frequently are located on the right-hand side console.

An instinct for excellence – CMATIC operation.

The unique DRIVESTICK with handrest on the side handles intuitively and gives full control of the HEXASHIFT or CMATIC transmission.

Unlike conventional drive levers, the DRIVESTICK comes with proportional control of a CMATIC transmission. This means that the further it is pushed or pulled when in drive lever mode, the faster the transmission accelerates or brakes the tractor.

This functionality is not needed so often in accelerator pedal mode as the driver controls the speed with the foot pedal. However, it is still very useful, for example to manually increase or reduce the engine braking effect.

When the DRIVESTICK is used in conjunction with the CMATIC transmission, it also has a cruise control button. Just press the button briefly to activate cruise control, or press and hold to save the current speed. If cruise control is active, the speed can be changed simply by moving the DRIVESTICK forwards or backwards. CIS+. Simply more.

CEBIS does it, so does CIS+.

- Set or activate individual flow and time control for individual spool valves
- Continuously variable PTO engagement/disengagement settings based on rear linkage height
- Record and run four CSM headland management sequences
- Operate ISOBUS implements using the F buttons on the tractor
- Implement controls tractor (ICT): with QUADRANT square balers or CARGOS loader wagons



The PTO speed and electronic rear linkage control system can be adjusted on the B-pillar.

CIS version.
Simply good.



Everything to hand.

The height and position of the armrest can easily be adjusted to the driver's requirements. All frequently used functions are located on the armrest.

- 1 DRIVESTICK to operate the HEXASHIFT transmission
- 2 Controls for rear linkage and two F buttons
- 3 GPS PILOT and two engine speed memories
- 4 Hand throttle
- 5 Fine tuning of engine speed memory
- 6 Control panel for transmission, HEXACTIV auto-shift function
- 7 ELECTROPILOT
- 8 Set working depth of rear linkage
- 9 Activate front and rear PTO
- 10 Mechanical spool valves



An instinct for excellence – HEXASHIFT operation.

The unique DRIVESTICK handles intuitively and gives full control of the HEXASHIFT transmission. Complex and cumbersome shifting operations are a thing of the past. All you need is nimble fingers to shift as you please.

The perfectly ergonomic armrest.

The multifunction armrest has been designed for optimum ergonomics and is the key to relaxed and effective working. It's the result of extensive analyses of the operating processes in the cab: frequently required functions are located on the multifunction armrest, while those required less frequently are located on the right-hand side console.



A question of settings.

Each spool valve has its own rotary switch. The function options for each spool valve are selected using the rotary switch allocated to it:

- Rotary switch in position III: Pressure – / Neutral / Pressure + / Float position
- Rotary switch in position III: Pressure – / Neutral / Pressure +
- Rotary switch in lock position: Spool valve locked in pressure position for permanent operation or in neutral position



The PTO speed and electronic rear linkage control system can be adjusted on the B-pillar.

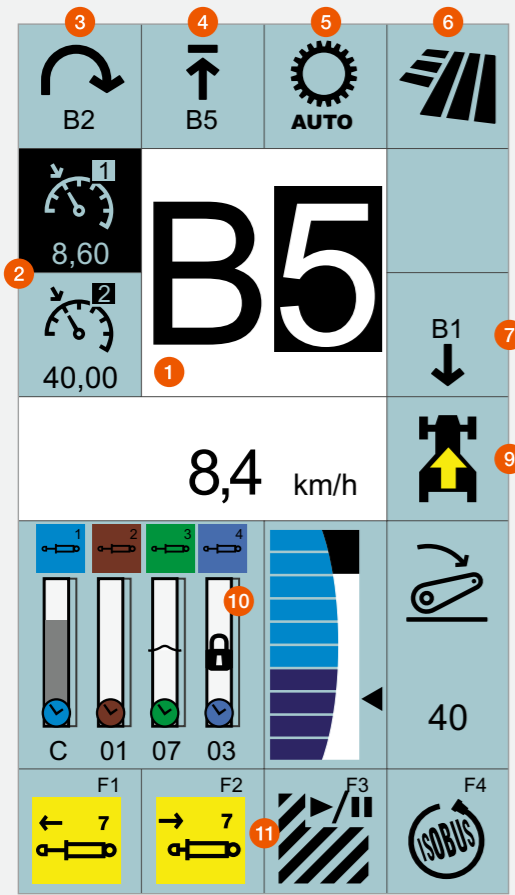

CIS colour display on the A-pillar with HEXASHIFT transmission.

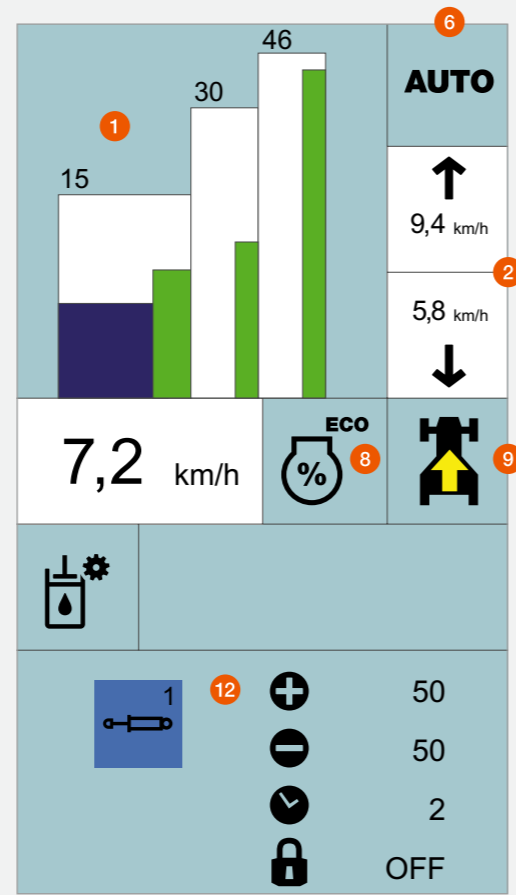

CIS colour display with CMATIC transmission and settings menu.

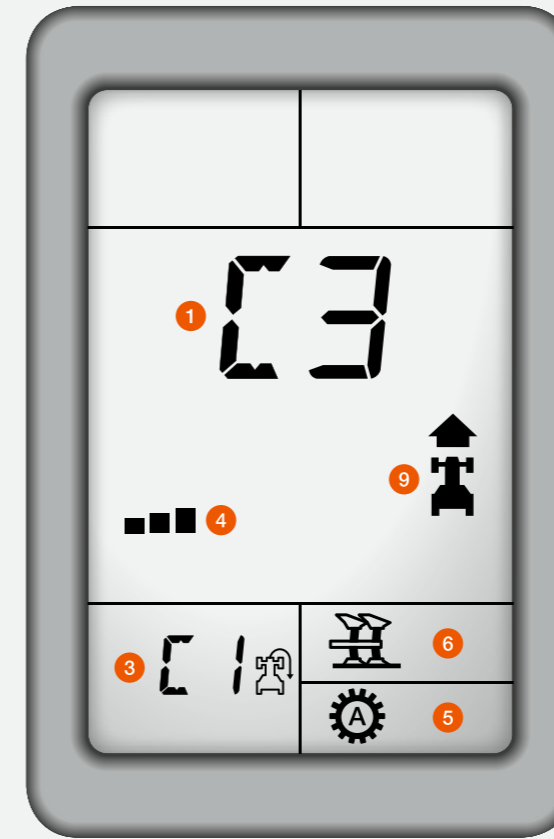

CIS display on the instrument panel and HEXASHIFT transmission display on the A-pillar.

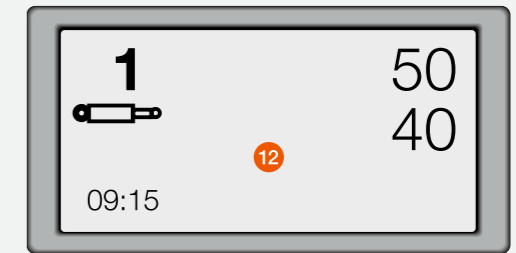

- 1 Current gear / CMATIC range
- 2 Cruise control and engine speed memory values
- 3 Selected headland gear
- 4 HEXACTIV auto-shift limiter
- 5 HEXACTIV mode
- 6 Current driving mode
- 7 Reverse gear
- 8 Selected engine droop
- 9 Direction of travel or transmission in neutral
- 10 Status of rear linkage and spool valves
- 11 Function button assignment
- 12 Settings menu

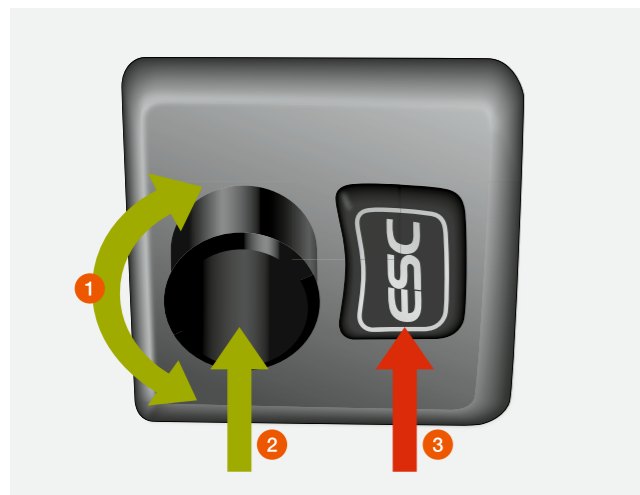

- 1 Menu navigation
- 2 Select
- 3 ESC button

The CLAAS INFORMATION SYSTEM (CIS).

In the CIS version, the display is built into the instrument panel. The additional HEXASHIFT display on the A-pillar shows all the information relating to the transmission at a glance.

CIS+:

The modern design of the 7" colour CIS display on the A-pillar provides the driver with full information about the transmission, electronic spool valves and F buttons. This colour CIS display shows the settings in the lower part of the screen. The logical, menu-guided interface and clear symbols make navigation very simple.

In both versions, all settings are easily activated using a rotary/push switch and the ESC button on the steering wheel.

The following functions can be set using the CIS:

- CMATIC or HEXASHIFT transmission settings
- Additional functions e.g. SMART STOP or dynamic steering
- Progressivity of the REVERSHIFT clutchless reverser
- Time and volume settings for the electronic spool valves
- On-board computer functions such as area worked, fuel consumption, area output
- Maintenance interval display

Ergonomics and comfort for optimum working conditions.



First-class comfort.

Many features of the working environment make the AXION the ideal choice for long working days. A large number of storage options mean that the driver can always find space for a mobile phone or documents. Under the passenger seat there is a cooler compartment which has room for two 1.5 litre bottles and snacks. Perfect for your lunch break.

LED headlights for perfect illumination.

If you're still working when it goes dark, the work lights will light up the whole of the area around the machine, so you can see exactly what you're doing. For even more demanding situations, up to 20 LED work lights and four LED road lights can illuminate the entire surroundings of the AXION almost as brightly as daylight.

A pleasant working environment.

All AXION models are fitted as standard with air conditioning and, optionally, with a category 3 filter. All components are built into the double-insulated cab floor to ensure quiet operation.



As well as the manually controlled air-conditioning system, a fully automated version is available which provides a pleasant flow of air through the cab.



Clear and logical layout.

The instrumental panel is mounted on a fully adjustable steering column. It pivots with the column to give an unimpeded view of the controls at all times.



Illuminated interior.

When the road lights are switched on, all the controls and the symbols on all the switches are illuminated. You have the option to select a darker colour scheme in CEBIS.



Leather on request.

The driver and passenger seat are available with modern, non-slip fabric or elegant, easy-care leather upholstery.



Sockets in easy reach.

All the sockets for the power supply as well as ISOBUS sockets for additional terminals are located under the right console.



NEW: Bluetooth connection.

The built-in Bluetooth handsfree device with external microphone allows you to make clear calls from the comfort of your cab.



NEW: more fresh air.

Choose between a front-opening transparent sunroof or a rear-opening roof hatch.



Wide-angle for better visibility.

As well as the large standard mirror, a wide-angle mirror for improved road safety is supplied as standard.



NEW: non-slip leather steering wheel.

The robust leather steering wheel provides a secure grip and an uninterrupted view of the instrument panel whatever position it's in.



NEW: tinted rear window.

The tinted rear window (optional) helps maintain a comfortable cab environment and reduces glare when you're working in the low evening sun.

Protects both driver and machine. The suspension.



Full 4-way suspension.

Four suspension points mean that the cab is fully isolated from the chassis, preventing impacts and vibration from reaching the driver. Longitudinal and lateral struts join the suspension points and keep the cab stable when turning corners or braking. The entire suspension system is completely maintenance-free.



Ventilated and warm: the premium seat.

Five Sears and Grammer seats are available, including a ventilated premium seat.

- Active seat ventilation makes the seat feel good whatever the weather
- Suspension automatically adjusts to the driver's weight



PROACTIV front axle suspension – complete comfort automatically.

The suspension adjusts to tractor loading and automatically remains in the central position. Changes in load due to braking and turning manoeuvres are also compensated for. Parallelogram axle suspension and 85 mm spring travel guarantee a smooth ride.



Vibration damping.

Heavy implements mounted on the front put a strain on the tractor as well as the driver. The front and rear linkage are both equipped with vibration damping to compensate for peak loads during transport operations and when the attached implement is raised at the headland.



Activate front axle suspension.

Operator assistance systems.

There is no substitute for your experience. It's what allows you to respond quickly and appropriately to the challenges you face in your daily work. When you're dealing with difficult terrain or changing soil conditions, you have to make decisions very quickly to get the job done to the right standard. That's why it's good to be able to count on a tractor with CEMOS to reduce your workload.

Data management.

Data have long since become an indispensable resource. To profit from their full potential, you should take good care of them, just as you would your machinery fleet. All systems, machines and work processes have to be meaningfully connected, and data generated must be sent to many different places for analysis.

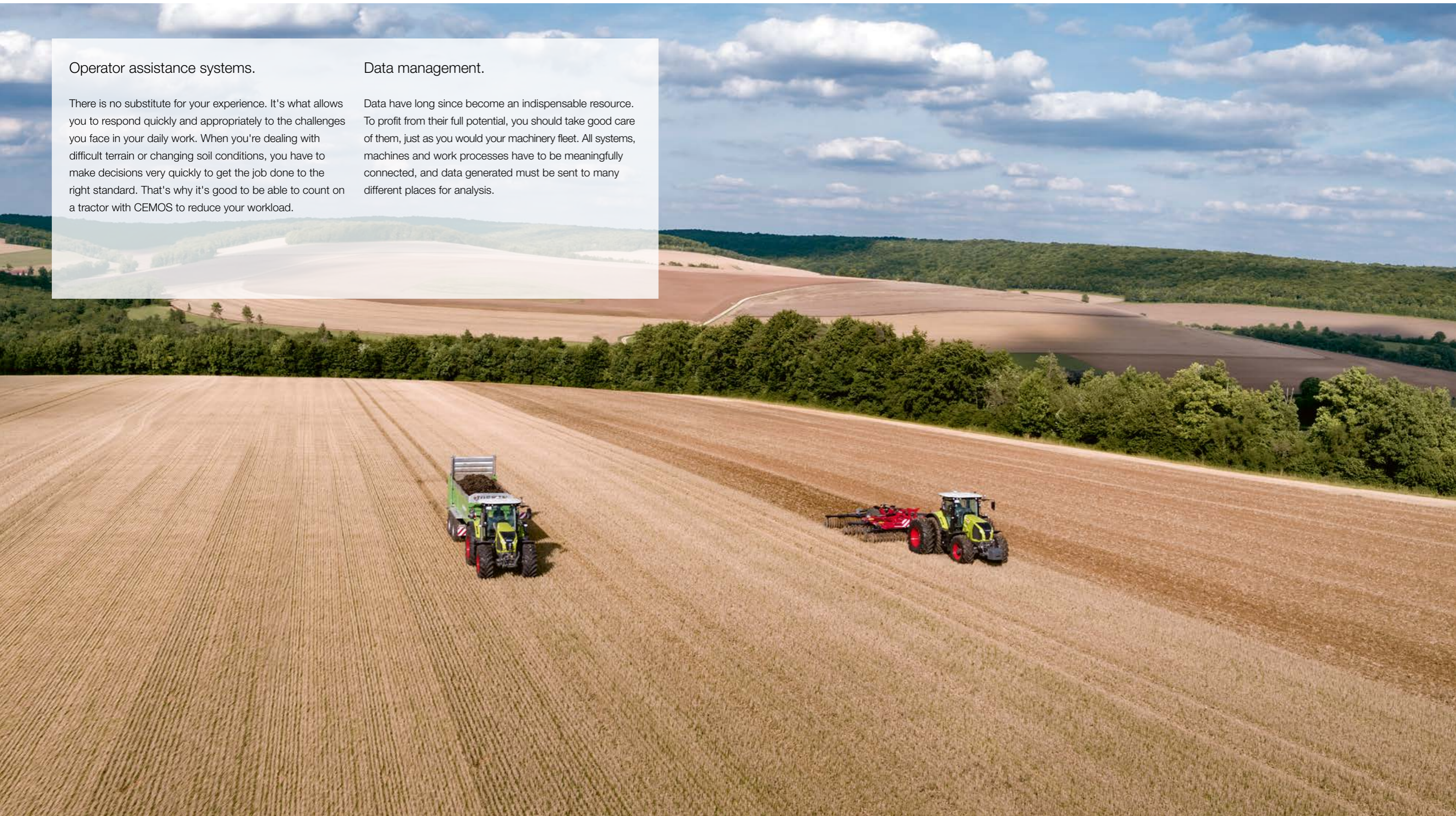

CEMOS for tractors. Makes good operators even better.



CEMOS for tractors was awarded a silver medal at Agritechnica 2017.

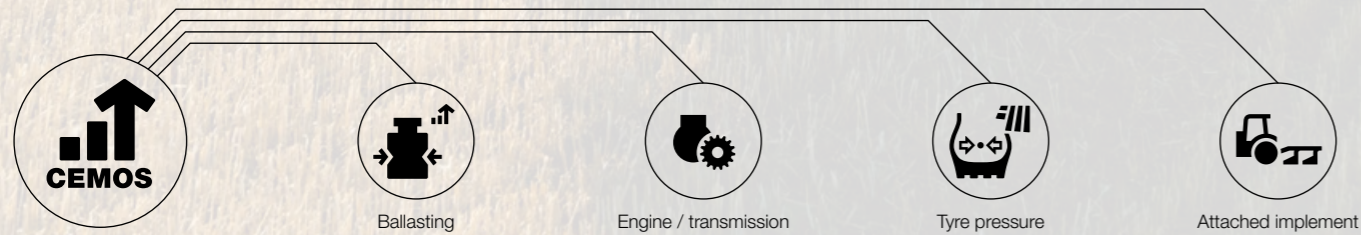

CEMOS teaches itself and trains the user.

The CEMOS self-learning operator assistance system is the only one of its kind on the market to optimise the performance of both the tractor and attached implements such as ploughs and cultivators. So it helps the driver set the correct ballast and tyre pressure. CEMOS uses a dialogue-based interface to make recommendations for all important settings, e.g. for the engine, transmission and implement. This helps to ensure optimum traction and soil protection at all times. With CEMOS you can increase your work rate, improve the quality of your work and reduce your fuel consumption by 12%.



Phase 1. Preparation in the farmyard.

CEMOS recommends the required ballasting and optimum tyre pressure to suit the selected implement and task before the driver has left the farmyard. The dynamic learning system gathers more measurements while work is under way, and adapts its recommendations accordingly next time around.

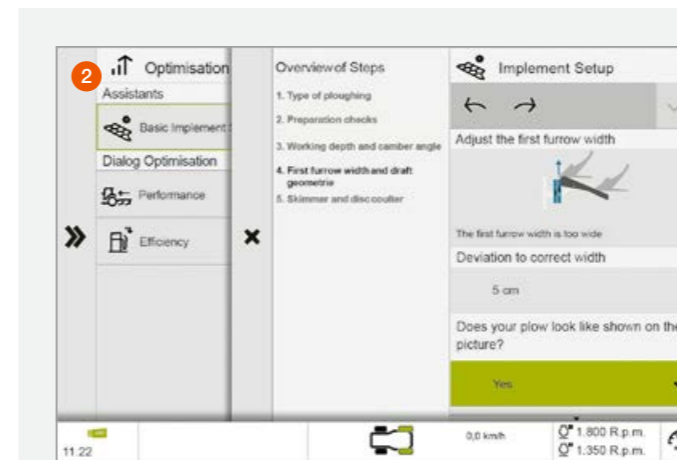

Phase 2. Basic setting in the field.

The integrated CEMOS knowledge database provides step-by-step instructions on basic settings for implements, with illustrations. Assist systems are now available for all ploughs. Further implements will follow in the near future. These provide valuable assistance for drivers working with new or unfamiliar implements.

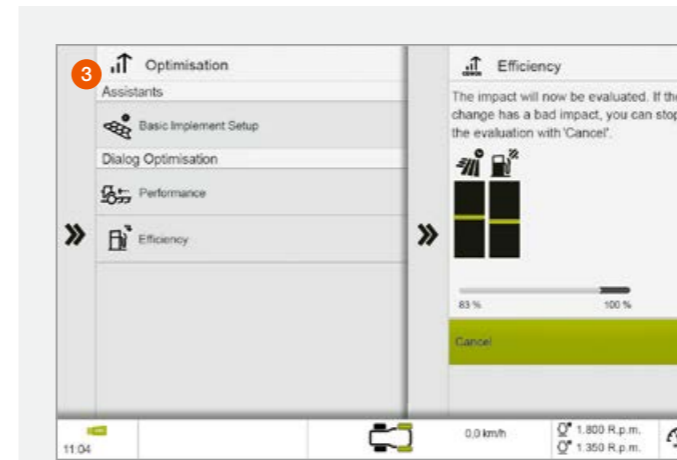

Phase 3. Optimisation while work is under way.

The driver opens the optimisation dialogue in the field. CEMOS checks all the basic settings, and offers suggestions for improving "performance" and "efficiency", which the driver can accept or reject. After each change of setting, CEMOS recalculates and shows whether the work rate and diesel consumption have improved, and by how much.



CLAAS SEQUENCE MANAGEMENT.

CSM headland management takes the load off you whenever you need to manoeuvre at the headland. By pressing a button, you can run any of the previously recorded functions.

	With CIS+	With CEBIS
Number of storable sequences	Four	Four per implement, up to 20 implements
Sequence activation	F buttons	CMOTION and F buttons
Sequence display	On CIS display	On CEBIS display
Recording mode	Time-related	Time- or distance-related
Edit function	–	Subsequent sequence optimisation in CEBIS

The following functions can be combined in any order:

- Spool valves with time and flow control
- Four-wheel drive, differential lock and front axle suspension
- Front and rear linkage
- Cruise control
- Front and rear PTO
- Engine speed memory

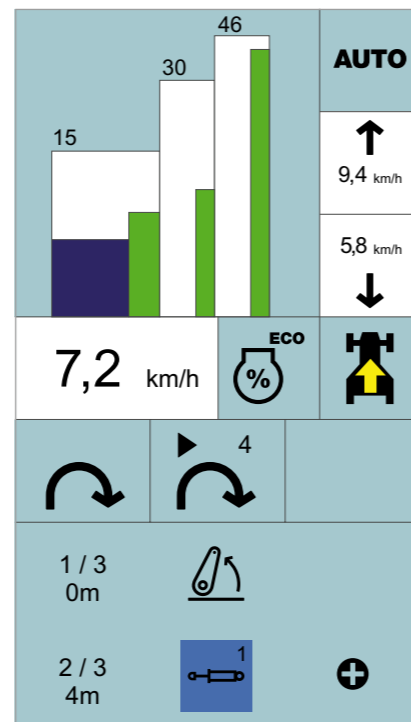

The sequence flow is shown in the lower area of the CIS colour display.



Easy to record and run.

Sequences can be recorded on a distance- or time-related basis. During recording, clear symbols allow the driver to follow the creation of the sequence step-by-step on the CEBIS or CIS colour display. A sequence that is running can be paused and restarted by simply pressing a button.

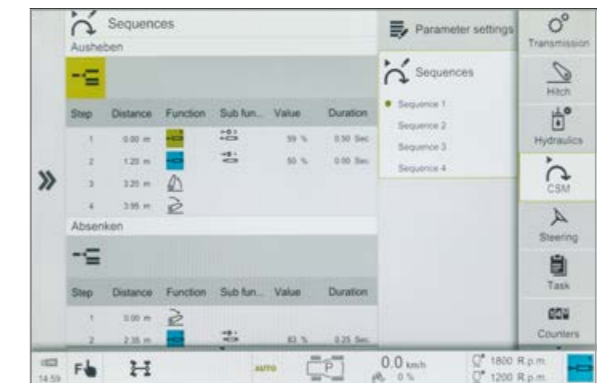

Non-stop optimisation with CEBIS.

Recorded sequences can be changed and optimised in CEBIS at a later date. Steps can be added and deleted or changed and adapted in minute detail, allowing times, distances and flow volumes to be tailored to current conditions. Once a sequence has been recorded, it can be refined down to the last detail in just a few steps.



The way you want it.

With the CEBIS version of the AXION, you can use the integrated terminal to control ISOBUS-compatible implements. Alternatively, portable displays from CLAAS offer flexible control options for ISOBUS and steering systems for all cab versions. You can also transfer the terminal from a tractor or self-propelled harvester to another machine, depending on the season or job in hand. Fit your AXION with the equipment you need straight from the factory or as a retrofit option.

S10 terminal:

- High-resolution 10.4" touchscreen terminal
- Steering and ISOBUS functions
- Up to four cameras can be displayed

S7 terminal:

- High-resolution 7" touchscreen terminal
- Steering functions

EASY on board app.

With the new EASY on board app, all ISOBUS-compatible implements can be controlled from a tablet¹. For even greater convenience, various functions can be assigned to the F buttons as with any other ISOBUS terminal.

ISOBUS implement control.

Sockets are provided at the front and rear to connect ISOBUS-compatible implements to the tractor. The ISOBUS-enabled terminal can be connected using another socket in the cab. The attached implement is operated by means of a machine-specific screen. ISOBUS compatibility means that implements from other manufacturers can also be operated using the S10 or CEBIS terminal.

¹ Apple iPad devices from IOS 9. A specific list of devices is provided in the description of the EASY on board app in the Apple App Store. A CWI (CLAAS Wireless Interface) is needed to connect to the in-cab ISOBUS connection.

Function buttons.

AXION tractors have up to ten F buttons to which different functions can be assigned in the CEBIS or CIS colour display. The current assignment can be viewed at any time in CEBIS or the CIS display window. The buttons are assigned to the corresponding function using the S10 or other ISOBUS terminals, enabling each driver to customise tractor operation to suit individual requirements.



F button assignment in CEBIS.

AXION 800 – AEF-compliant.

The Agricultural Industry Electronics Foundation (AEF) is a partnership between approximately 150 companies, associations and organisations. Its aim is to harmonise development standards in electronic systems for agriculture, such as ISOBUS components. These systems comply with the ISO 11783 standard, but more detailed AEF guidelines are also being developed. The AXION 800 was developed according to these requirements and supports the ISOBUS functionality specifications ISO UT 1.0, TECU 1.0, AUX-O and AUX-N for ISOBUS implements.



ICT CRUISE CONTROL and AUTO STOP were awarded a silver medal at Agritechnica 2013.

ICT (Implement Controls Tractor).

Thanks to ISOBUS, when the AXION is used in combination with the QUADRANT square baler or CARGOS loader wagon, two AXION CMATIC functions can be automatically controlled by the implement:

ICT CRUISE CONTROL:

Optimises the performance and work quality of the implement by controlling the tractor's forward speed. The speed is continuously adjusted to suit the current conditions, enabling you to get the best out of your machine combination.

ICT AUTO STOP:

If an overload is detected in the implement, the ICT AUTO STOP function automatically switches off the PTO. This protects the entire drive train throughout long working days and reduces the driver's workload.

Always on the right track. CLAAS steering systems.

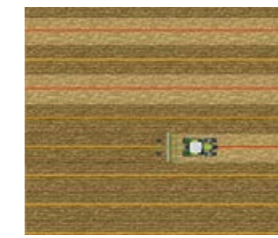

RTK NET (accuracy $\pm 2-3$ cm)

- Correction signal via mobile phone network
- Unrestricted working radius

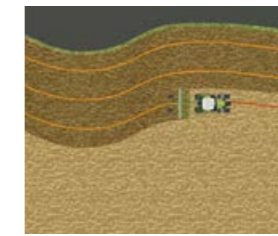

RTK FARM BASE LINK (accuracy $\pm 2-3$ cm)

- Base station
- Station data transmitted via the mobile phone network (NTRIP)
- Operating radius 30 km

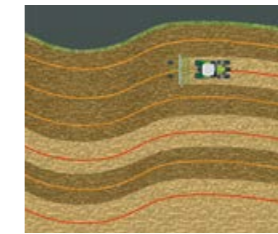

RTK FARM BASE (accuracy $\pm 2-3$ cm)

- Base station with digital and analog radio can be used
- Range up to 15 km



RTK FIELD BASE (accuracy $\pm 2-3$ cm)

- Mobile reference station
- Range 3-5 km

SATCOR

- Satellite-based correction signal from CLAAS
- Virtually worldwide coverage

SATCOR 15 (accuracy ± 15 cm)

- Improved basic accuracy
- Quick signal availability
- Good signal suitable for many applications from soil cultivation to harvesting

SATCOR 5 (accuracy ± 5 cm)

- Ideal in areas where RTK and mobile phone coverage is patchy
- Longer initialisation period than SATCOR 15 but more accurate

EGNOS / E-DIF (accuracy ± 30 cm)

- No licence fee
- Basic accuracy

Improve the quality of your work.

CLAAS steering systems take the pressure off the driver. They show in advance which direction to take, or automatically steer the tractor along the best possible path. Mistakes and overlapping are eliminated. Studies have shown that a modern parallel guidance system can save up to 7% on fuel, machine costs, fertiliser and crop protection products.

The GPS PILOT automatic steering system is controlled by the S10 and S7 touchscreen terminals (see pages 64 / 65) which feature a very simple and user-friendly menu-guided interface.

Automatic steering at the headland.

The AUTO TURN function takes care of turning manoeuvres at the headland. The direction of the turn and the next track to be worked are pre-selected on the terminal. The steering system does the rest.

Correction signal to meet individual needs.

The design of the CLAAS range enables you to extend your system easily at any time. This applies just as much to the terminal technology as to the use of today's essential correction signals.

CLAAS steering systems can be used with GPS and GLONASS satellite systems to enhance their flexibility and operational capabilities.



With AUTO TURN the tractor turns automatically at the headland.



Cutting your costs per hectare with more precision.
steeringsystems.claas.com

Keep track of all machines and jobs. All the time.

CLAAS TELEMATICS.

TELEMATICS allows you to call up any information about your machine at any time from any location. The data collected are sent to the TELEMATICS web server via the mobile phone network.

This enables you or an authorised service partner to access and evaluate the relevant information via the internet.

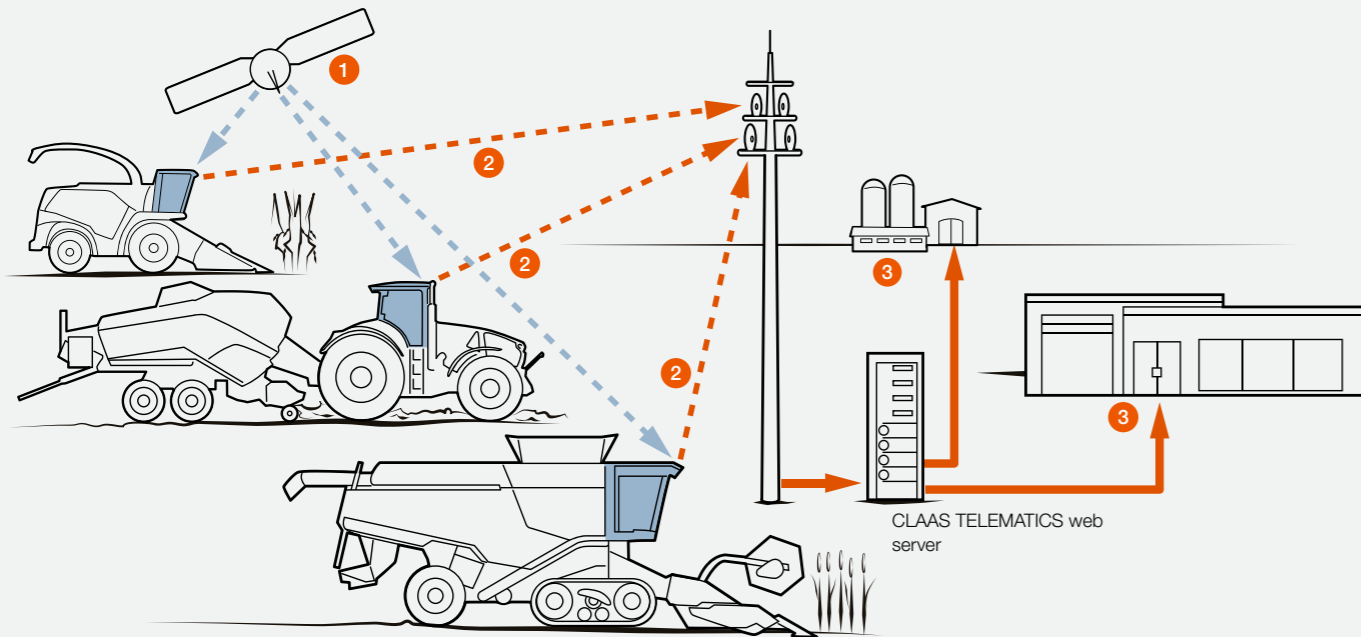

- 1 Machines receive signals transmitted by GPS satellites.
- 2 Machines send the GPS coordinates, machine-related performance data and reports to the TELEMATICS web server via the mobile phone network.
- 3 These data are directly accessible to farms or service partners via the internet.

CLAAS TELEMATICS functions.

Improve your work processes with operating time analysis.

- Analyse working time
- Reduce downtime
- Optimise fuel consumption

Optimise your settings with remote monitoring.

- Position displayed in Google Earth®
- Current activity
- Review machine settings

Simplify your documentation with data collection.

- Automatic data collection for documentation
- Secure storage on central server
- Standard interfaces for data export from TELEMATICS

Save service time with remote diagnostics.

- Maintenance planning
- Remote diagnostics with CDS



Connect your machines.
Optimise your jobs.
connected-machines.claas.com

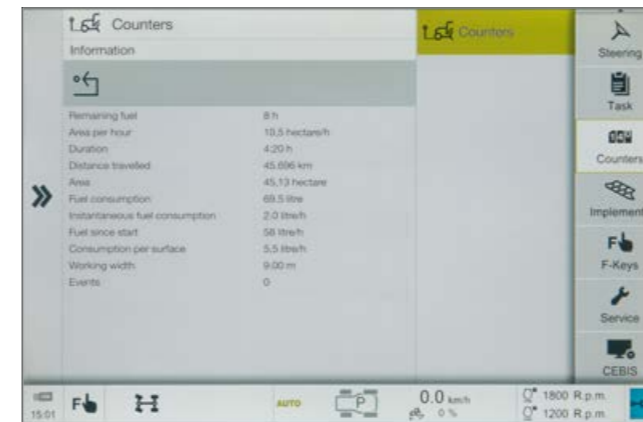

Field management with CEBIS.

Up to 20 jobs can be set up and stored in CEBIS in order to produce documentation for the work done. Enter the working width first, then you can start area calculation and the fuel consumption display per hectare. To get the most accurate results, the speed can be measured by radar.

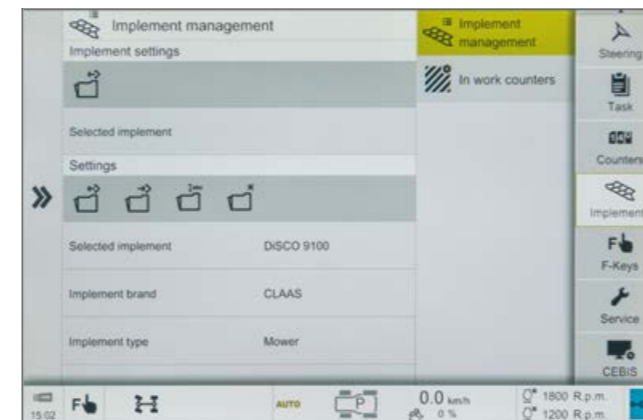

Implement management with CEBIS.

With CEBIS, details of up to 20 implements can be recorded. All the preset values are permanently assigned to the specific implement.

- Settings for transmission and hydraulic spool valves
- Four CSM sequences
- Area calculation - mode and activation
- Working width of attached implement
- Transfer settings from one tractor to another via USB stick

This saves on unnecessary adjustment tasks when changing implement or driver. Just attach the implement, load the implement in CEBIS and start work.



DataConnect: the first direct cloud-to-cloud solution for agricultural machinery.

Until now, farmers with mixed machine fleets have been able to display, process and document data only at the level of individual machines or on manufacturer portals. With DataConnect, CLAAS, 365FarmNet, John Deere, Case, Steyr and New Holland have created the first direct multi-manufacturer, industry-wide open cloud-to-cloud solution. The machines transmit their data via an interface, allowing you to control and monitor your entire machinery fleet in the CLAAS TELEMATICS portal.



Good access saves time and money.

Daily maintenance work should be as straightforward as possible – because we know from experience that nobody enjoys doing things that are complicated or inconvenient.

- The large, one-piece bonnet opens at the press of a button, providing access to all the engine maintenance points
- The engine oil can be checked and topped up on the left-hand side of the tractor when the bonnet is closed
- All daily maintenance tasks can be carried out without tools
- The front axle lubrication points are located in front of the radiator assembly for optimum accessibility
- The fuel prefilter is conveniently located by the left-hand cab access ladder.
- Large drawer in the left-hand access ladder with space for a standard toolbox

The long oil-change intervals (engine 600 h, transmission and hydraulics 1,200 h) save time and money. As a result, less valuable working time is lost during the season and the tractor is where it should be – at work.

Fresh air for full power.

The large intake panels in the bonnet provide plenty of fresh air for cooling and for the engine air filter. Low flow rates at the intake panels keep them clean and permeable at all times.

The radiator assemblies are supported by a robust frame and have gas-filled shock absorbers that open the radiator panels to two positions for thorough cleaning. So cleaning can be carried out safely and conveniently as and when it is needed.

The air filter is accessibly located in the cool zone in front of the radiator panels so it can easily be removed. Coarse dirt particles are extracted in the filter housing, further extending the cleaning interval.

Maintenance Overview	
Next maintenance in 10 hours	10 h
Next maintenance in 50 hours	38 h
Next maintenance in 100 hours	88 h
Next maintenance in 500 Hours	488 h
Next maintenance in 1000 hours	988 h

Maintenance counter in the CEBIS and CIS display.



The front axle lubrication points are located in front of the radiator assembly for optimum accessibility.



A lubrication chart under the bonnet simplifies maintenance.



The battery is conveniently positioned above the right-hand access ladder.

Whatever it takes. CLAAS Service & Parts.



Safeguard your machine's reliability.

Increase your operating reliability, minimise the risk of breakdown and repair. MAXI CARE offers you predictable costs. Create your own individual service package to meet your particular requirements.



CLAAS Service & Parts
is there for you 24/7.
service.claas.com



Specially matched to your machine.

Precision-manufactured parts, high-quality consumables and useful accessories. Choose our comprehensive product range to be certain of receiving exactly the right solution to ensure 100% operating reliability for your machine.



For your business: CLAAS FARM PARTS.

CLAAS FARM PARTS offers one of the most comprehensive ranges of multi-brand parts and accessories for all agricultural applications on your farm.



Global supply.

The CLAAS Parts Logistics Center in Hamm, Germany, stocks almost 200,000 different parts and has a warehouse area of over 140,000 m². This central spare parts warehouse delivers all ORIGINAL parts quickly and reliably all over the world. This means that your local CLAAS partner can supply the right solution for your harvest or your business within a very short time.



Your local CLAAS distributor.

Wherever you are, you can count on us to always provide you with the service and the contact persons you need. Your CLAAS partners are on hand in your local area, ready to support you and your machine around the clock. With know-how, experience, commitment and the best technical equipment. Whatever it takes.

These outstanding features speak for themselves.



CPS.

- FPT engines for high performance and low fuel consumption
- HEXASHIFT powershift transmission with HEXACTIV auto-shift function, cruise control and SMART STOP
- CMATIC continuously variable transmission available in CEBIS or CIS+ version
- Long wheelbase and balanced weight distribution
- Rear tyres up to 900 mm wide and 2.05 m in diameter
- Dual tyres at the rear with 2.5 m quick-release axle available in the AXION 850 and 870 for heavy traction work
- Choice of 540, 1000, 540 ECO or 1000 ECO PTO mode
- Up to seven spool valves and 205 l/min hydraulic capacity
- K80 ball hitch with up to 4 t drawbar load

Comfort and convenience.

- 4-pillar cab
- Three equipment options available: CEBIS, CIS+ or CIS
 - CMOTION multifunction control lever in the CEBIS version
 - Multifunction armrest with DRIVESTICK in the CIS+ and CIS version
- 4-point cab suspension
- Driver's seats with active suspension and ventilation
- PROACTIV front axle suspension
- Front and rear linkage with vibration damping
- Optimum accessibility and labelling for all maintenance points
- Drawer with toolbox built into the tractor
- GPS PILOT with S10 and S7 touchscreen terminal
- CSM headland management
- CEMOS for tractors
- Implement management
- TELEMATICS
- ISOBUS implement control via CEBIS or S10 terminal
- Implement Controls Tractor (ICT) when the AXION is combined with the QUADRANT or CARGOS

AXION		870	850	830	810	800
Engine						
Manufacturer		FPT	FPT	FPT	FPT	FPT
Number of cylinders		6	6	6	6	6
Cubic capacity	cm ³	6728	6728	6728	6728	6728
Variable geometry turbo		●	●	●	●	●
Engine fan		VISCTRONIC	VISCTRONIC	VISCTRONIC	VISCTRONIC	Visco coupler
Rated output (ECE R 120) ¹	kW/hp	199/270	184/250	165/225	151/205	142/194
Max. output (ECE R 120) ¹	kW/hp	206/280	194/264	173/235	158/215	150/205
Max. output with CPM (ECE R 120) ¹	kW/hp	217/295	–	–	–	–
Rated output type approval value for HEXASHIFT models ²	kW/hp	–	186/253	168/228	153/208	142/193
Rated output type approval value for CMATIC models ²	kW/hp	209/284	192/261	179/243	168/228	–
Max. output type approval value for HEXASHIFT models ²	kW/hp	–	194/264	175/238	161/219	150/204
Max. output type approval value for CMATIC models ²	kW/hp	221/300	204/277	188/255	175/238	–
Max. torque	Nm	1276	1132	1016	941	896
Max. fuel tank capacity	l	455	455	455	455	455
Oil-change interval	h	600	600	600	600	600
CMATIC continuously variable transmission						
REVERSHIFT clutchless reverser		●	●	●	●	●
Min. speed at rated engine speed	km/h	0.05	0.05	0.05	0.05	–
Max. speed	km/h	40/50	40/50	40/50	40/50	–
HEXASHIFT powershift transmission						
Number of gears		–	24/24	24/24	24/24	24/24
Powershift speeds		–	6	6	6	6
Electronically controlled ranges		–	4	4	4	4
REVERSHIFT clutchless reverser		–	●	●	●	●
Min. speed at rated engine speed	km/h	–	1.59	1.70	1.63	1.63
Min. speed with creep gear at rated engine speed	km/h	–	0.44	0.47	0.45	0.45
Max. speed	km/h	–	40/50	40/50	40/50	40/50
Rear axle						
Max. diameter of rear tyres	m	2.05	2.05	2.05	2.05	1.95
Widest rear tyres		900/60 R 38	900/60 R 38	900/60 R 38	900/60 R 38	710/70 R 38
Flanged axle		●	●	●	●	●
Quick-release axle 2.5 or 3.0 m wide		○	○	○	○	○
Automatic differential lock		●	●	●	●	●
Park-lock		●	●	●	●	●
Oil-change interval	h	1200	1200	1200	1200	1200
PTO						
External operation of engagement and emergency stop		●	●	●	●	●
540 / 1000		●	●	●	●	●
540 / 540 ECO / 1000		○	○	○	○	○
540 ECO / 1000 / 1000 ECO		○	○	○	○	○
PTO shaft stub: 1 3/8" with 6 or 21 splines and 1 3/4" with 20 splines		□	□	□	□	□
Four-wheel drive front axle						
Rigid front axle		●	●	●	●	●
PROACTIV suspended front axle		○	○	○	○	○
Automatic 4-wheel drive		●	●	●	●	●
Turning radius	m	5.31	5.31	5.31	5.31	5.31

¹ Meets ISO TR 14396

² Performance data fit criteria for admissibility.

● standard ○ optional □ available – not available

AXION		870	850	830	810	800
Hydraulics						
Load-sensing hydraulics 110 l/min		●	●	●	●	●
Load-sensing hydraulics 150 l/min		○	○	○	○	○
Load-sensing hydraulics 205 l/min		○	○	○	○	○
Max. operating pressure	bar	200	200	200	200	200
Number of mechanical spool valves		–	3–4	3–4	3–4	3–4
Number of electronic spool valves		3-7	3-7	3-7	3-7	3-7
Two central electronic spool valves, operated from ELECTROPILOT		○	○	○	○	○
Flow rate control		●	●	●	●	●
Rear linkage						
Max. lifting capacity at ball ends	kg	10200	10200	9700	9500	9500
Continuous lifting power at ball ends	kg	6200	6200	6200	6200	6200
Vibration damping		●	●	●	●	●
External controls		●	●	●	●	●
Active wheel slip control		○	○	○	○	○
Front linkage						
Lift capacity	t	4.7 / 5.9	4.7 / 5.9	4.7 / 5.9	4.7 / 5.9	4.7 / 5.9
Front PTO 1000 rpm		○	○	○	○	○
Vibration damping		●	●	●	●	●
Position control		○	○	○	○	○
External front linkage operation		○	○	○	○	○
Four additional hydraulic connections		○	○	○	○	○
External operation of additional connections		○	○	○	○	○
ISOBUS and trailer socket		○	○	○	○	○
Cab						
CIS version		–	●	●	●	●
CIS+ version		●	○	○	○	○
CEBIS version		○	○	○	○	○
4-point suspension		●	●	●	●	●
Multifunction armrest		●	●	●	●	●
Air conditioning		●	●	●	●	●
Automatic climate control		○	○	○	○	○
Passenger seat with integral cool box		●	●	●	●	●
Data management and operator assistance systems						
CEMOS		○	○	○	○	○
CSM headland management		○	○	○	○	○
ISOBUS and ICT		○	○	○	○	○
GPS PILOT ready		○	○	○	○	○
GPS PILOT steering system		○	○	○	○	○
TELEMATICS		●	●	●	●	●

CLAAS continually develops its products to meet customer requirements. This means that all products are subject to change without notice. All descriptions and specifications in this brochure should be considered approximate and may include optional equipment that is not part of the standard specifications. This brochure is designed for worldwide use. Please refer to your nearest CLAAS dealer and their price list for local specification details. Some protective panels may have been removed for photographic purposes in order to present the function clearly. To avoid any risk of danger, never remove these protective panels yourself. In this respect, please refer to the relevant instructions in the operator's manual. All technical specifications relating to engines are based on the European emission regulation standards: Stage. Any reference to the Tier standards in this document is intended solely for information purposes and ease of understanding. It does not imply approval for regions in which emissions are regulated by Tier.

● standard ○ optional □ available – not available



Sales, service and support – our team is here to help.
contact.claas.com

AXION		870	850	830	810	800
-------	--	-----	-----	-----	-----	-----

Dimensions and weights

Standard equipment						
Overall height (a)	mm	3215	3215	3215	3215	3215
Length: front linkage folded (b)	mm	5428	5428	5428	5428	5428
Wheelbase (c)	mm	2980	2980	2980	2980	2980
Ground clearance, front axle (d)	mm	470	470	470	470	470
Ground clearance, rear axle (e)	mm	526	526	526	526	526
Weight	kg	9050 / 9450	8700 / 9450	8400 / 9150	8300 / 9050	8300 / 8600



Ensuring a better **harvest.**

CLAAS UK
 Saxham
 Bury St. Edmunds
 Suffolk
 IP28 6QZ
 Tel 01284 763100
 claa.co.uk
 info-uk@claa.com

365FarmNet enables you to manage your entire agricultural business by means of a single, non-proprietary software solution. Interfaces to intelligent applications created by partners in the agricultural sector offer expert support for your business 365 days a year. CLAAS is a 365FarmNet partner.

www.365farmnet.com

